



## Latest generation testo air velocity & IAQ probes with Bluetooth® handle

0554 1111

Instruction manual





# Contents

<b>1</b>	<b>Safety and disposal</b> .....	<b>3</b>
<b>2</b>	<b>System description</b> .....	<b>4</b>
<b>3</b>	<b>Description of the instrument</b> .....	<b>6</b>
3.1	Bluetooth® handle for connecting testo 440 probe heads (0554 1111) ..	6
3.2	Hot wire probe with Bluetooth®, including temperature and humidity sensor (0635 1571) .....	7
3.3	Vane probe (Ø 16 mm) with Bluetooth®, including temperature sensor (0635 9571) .....	9
3.4	High-precision vane probe (Ø 100 mm) with Bluetooth®, including temperature sensor (0635 9371) .....	10
3.5	Vane probe (Ø 100 mm) with Bluetooth®, including temperature sensor (0635 9431) .....	12
3.6	High-precision temperature/humidity probe with Bluetooth® (0636 9771) .....	13
3.7	Temperature/humidity probe with Bluetooth® (0636 9731) .....	14
3.8	CO <sub>2</sub> probe with Bluetooth®, including temperature and humidity sensor (0632 1551) .....	15
3.9	CO probe with Bluetooth® (0632 1271) .....	16
<b>4</b>	<b>Commissioning</b> .....	<b>17</b>
<b>5</b>	<b>Maintenance</b> .....	<b>18</b>
5.1	Maintaining the probes .....	18
5.1.1	Cleaning the instrument .....	18
5.1.2	Calibration .....	18
<b>6</b>	<b>Questions and answers</b> .....	<b>19</b>
<b>7</b>	<b>Technical data</b> .....	<b>19</b>
<b>8</b>	<b>Accessories and spare parts</b> .....	<b>25</b>



# 1 Safety and disposal

## About this document

- The instruction manual is an integral part of the instrument.
- Please read this instruction manual through carefully and familiarize yourself with the product before putting it to use.
- Pay particular attention to the safety instructions and warning advice in order to prevent injury and damage to the product.
- Keep this documentation to hand so that you can refer to it when necessary.
- Always use the complete original instruction manual.
- Hand this instruction manual on to any subsequent users of the product.

## Security

- Only use the product properly, for its intended purpose, and within the parameters specified in the technical data. Do not apply any force.
- Dangers may also arise from the systems being measured or the measuring environment: always comply with the locally valid safety regulations when carrying out measurements.
- Do not carry out any contact measurements on uninsulated, live parts.
- Do not store the product together with solvents. Do not use any desiccants.
- Only carry out maintenance and repair work on this instrument which is described in the documentation. Follow the prescribed steps exactly when doing the work. Use only original spare parts from Testo.
- Temperature information given on probes/sensors relates only to the measuring range of the sensor technology. Do not expose handles and feed lines to temperatures in excess of 50°C (122°F), unless they are expressly authorized for use at higher temperatures.
- Do not operate the instrument if there are signs of damage on the housing or supply lines.

### **Batteries**

- Improper use of batteries may cause destruction of the batteries, injuries due to current surges, fire or the escape of chemicals.
- Only use the batteries supplied in accordance with the instructions in the instruction manual.
- Do not short, take apart or modify batteries.
- Do not expose the batteries to heavy impacts, water, fire or temperatures above +140 °C or below -20 °C.
- Do not store unused batteries in the proximity of metal objects.
- Do not use any leaky or damaged batteries.
- In the event of contact with battery acid: rinse affected areas thoroughly with water, and if necessary consult a doctor.

### **Disposal**

- Dispose of faulty rechargeable batteries and spent batteries in accordance with the valid legal specifications.
- At the end of its useful life, deliver the product to the separate collection point for electric and electronic devices (observe local regulations) or return the product to Testo for disposal.

## **2 System description**

You have acquired a probe with Bluetooth®. This probe comprises a handle, a probe head and, if applicable, additional probe-specific accessories. The handle can be connected to all the system's probe heads and attachments. The graphic below shows what options the system offers.



You will find detailed information about how each of the probes works along with the testo 440 measuring instrument in the corresponding chapter of the instruction manual for the measuring instrument.

---

System overview

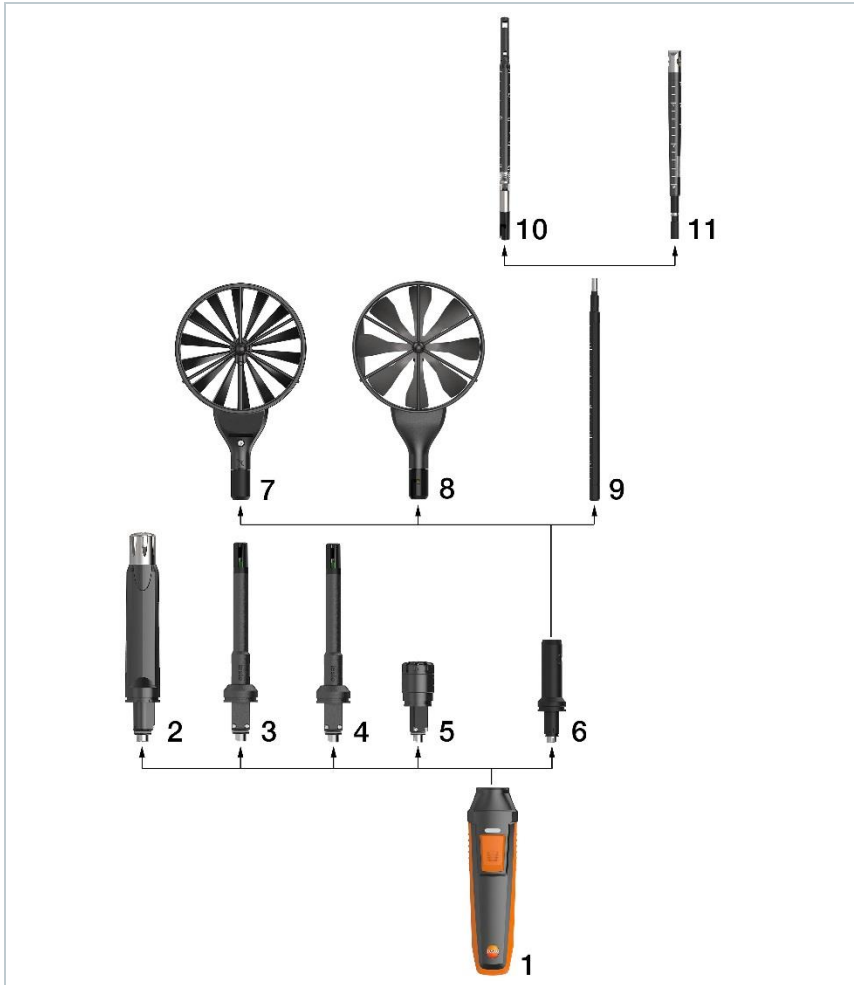

1	Bluetooth® handle for connecting testo 440 probe heads (order no. 0554 1111)	2	CO <sub>2</sub> probe head, including humidity and temperature sensor (order no. 0632 1550)
3	High-precision temperature/humidity probe head (order no. 0636 9770)	4	Temperature/humidity probe head (order no. 0636 9730)
5	CO probe head (order no. 0632 1270)	6	Handle adapter for connecting testo 440 flow probes (order no. 0554 2160)

<b>7</b>	100 mm vane probe head (order no. 0635 9430)	<b>8</b>	High-precision 100 mm vane probe head, including temperature sensor (order no. 0635 9370)
<b>9</b>	Extendable telescope for testo 440 flow probes, including 90° angle (order no. 0554 0960)	<b>10</b>	Hot wire probe head, including temperature and humidity sensor (order no. 0635 1570)
<b>11</b>	16 mm vane probe head, including temperature sensor (order no. 0635 9570)		

### 3 Description of the instrument

#### 3.1 Bluetooth® handle for connecting testo 440 probe heads (0554 1111)

##### Application

The handle with Bluetooth® 0554 1111 is used for the wireless connection of probe heads to the testo 440 measuring instrument.



Observe the information on the measuring process in the detailed instrument instruction manual. You will find this at: [www.testo.com](http://www.testo.com).

##### Structure

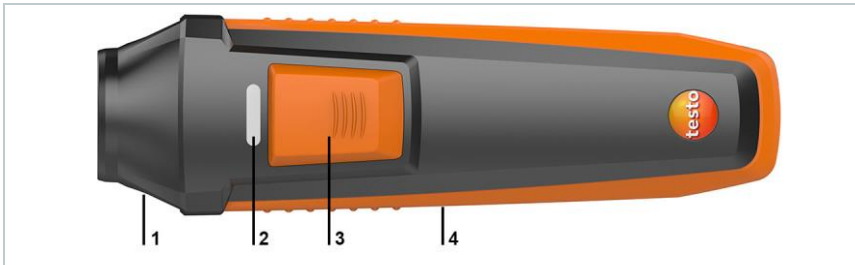

Element	Element
<b>1</b> Quick-release connector for probe heads and adapter	<b>2</b> LED status display
<b>3</b> Button	<b>4</b> Battery compartment (on rear)



**Remove battery safety strips**

- 1 Pull safety strips out of the battery compartment.



## 3.2 Hot wire probe with Bluetooth®, including temperature and humidity sensor (0635 1571)

**Use**

In conjunction with the testo 400 / testo 440, the hot wire probe is suitable for flow and humidity measurements in ventilation ducts.

**Structure**

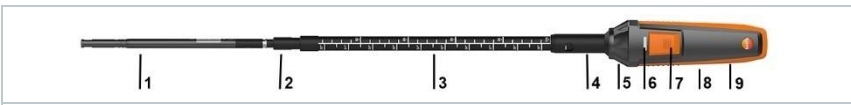

1	Probe head	2	Probe head connection
3	Telescope	4	Handle adapter
5	Quick-release connector for probe heads and adapter	6	LED status display
7	Button	8	Bluetooth® handle
9	Battery compartment (on rear)		

**CAUTION**

**Damage to sensor possible!**

- Do not touch sensor!
- Put the protective sleeve on after the measurement.



Low flow velocities may result in greater measurement uncertainties during temperature and humidity measurement. The probe should be switched on outside a duct under the following conditions:

Ambient temperature: 20°C

Flow: approx. 0 m/s.

#### Connect hot wire probe to the handle

1 Turn quick-release connector, viewed from the handle end, through 90° anticlockwise until it locks in place.



2 Insert handle adapter into the handle (pay attention to coding).



3 Turn quick-release connector back through 90° until it locks in place.

4 Insert telescope into the handle adapter (pay attention to the guide groove and guide pin).



5 Push telescope in slightly and turn to lock in place.

6 Push probe head onto the telescope (pay attention to the guide groove and guide pin).



7 Push probe head in slightly and turn to lock in place.

▶ The hot wire probe is ready to use.

#### Carrying out the measurement

When taking measurements in flows, the arrow mark on the probe head must point in the direction of flow.

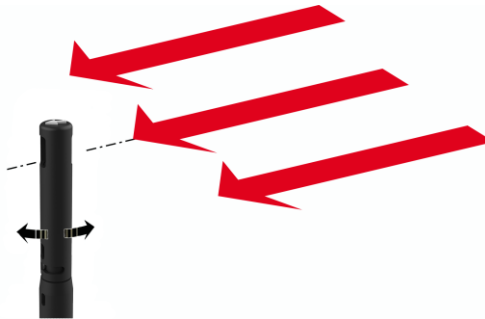

The correct measuring value is determined by rotating the probe slightly in both directions until the maximum value is displayed.

### 3.3 Vane probe (Ø 16 mm) with Bluetooth<sup>®</sup>, including temperature sensor (0635 9571)

#### Application

In conjunction with the testo 440 / testo 440, the vane probe (Ø 16 mm) is suitable for flow measurements in ventilation ducts.

#### Structure

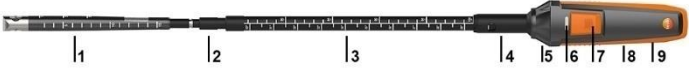
			
1	Probe head	2	Probe head connection
3	Telescope	4	Handle adapter
5	Quick-release connector for probe heads and adapter	6	LED status display
7	Button	8	Bluetooth <sup>®</sup> handle
9	Battery compartment (on rear)		

#### CAUTION

#### Damage to sensor possible!

- Do not touch sensor!
- Put the protective sleeve on after the measurement.

#### Connect the vane probe (Ø 16 mm) to the handle

- 1 Turn quick-release connector, viewed from the handle end, through 90° anticlockwise until it locks in place.



- 2 Insert handle adapter into the handle (pay attention to coding).



- 3 Turn quick-release connector back through 90° until it locks in place.

- 4 Insert telescope into the handle adapter (pay attention to the guide groove and guide pin).



- 5 Push telescope in slightly and turn to lock in place.

- 6 Push probe head onto the telescope (pay attention to the guide groove and guide pin).
  - 7 Push probe head in slightly and turn to lock in place.
- ▶ The vane probe ( $\varnothing$  16 mm) is ready to use.



#### Carrying out the measurement

Position the probe as illustrated. The arrow mark on the probe head must point in the direction of flow.



The correct measuring value is determined by rotating the probe slightly in both directions until the maximum value is displayed.

## 3.4 High-precision vane probe ( $\varnothing$ 100 mm) with Bluetooth<sup>®</sup>, including temperature sensor (0635 9371)

#### Application

In conjunction with the testo 440, the high-precision vane probe ( $\varnothing$  100 mm) is used for flow measurement, e.g. at ventilation outlets.

**Structure**



1	Probe head	2	Handle adapter
3	Quick-release connector for probe heads and adapter	4	LED status display
5	Button	6	Bluetooth® handle
7	Battery compartment (on rear)		

**CAUTION**

**Damage to sensor possible!**

- Do not touch sensor!



The testovent bracket included in the package is intended for the testovent 417 measurement funnel.

**Connect high-precision vane probe (Ø 100 mm) to the handle**

- 1 Turn quick-release connector, viewed from the handle end, through 90° anticlockwise until it locks in place.



- 2 Insert handle adapter into the handle (pay attention to coding).



- 3 Turn quick-release connector back through 90° until it locks in place.

- 4 Insert probe head into the handle adapter (pay attention to the guide groove and guide pin).



- 5 Push probe head in slightly and turn to lock in place.

- ▶ The high-precision vane probe is ready to use.



If necessary, the telescope (order no. 0554 0960) and the 90° angle (order no. 0554 0991) can be connected, e.g. for measurements at ceiling outlets.

### 3.5 Vane probe (Ø 100 mm) with Bluetooth®, including temperature sensor (0635 9431)

#### Application

In conjunction with the testo 440, the vane probe (Ø 100 mm) is used for flow measurement, e.g. at ventilation outlets.

#### Structure

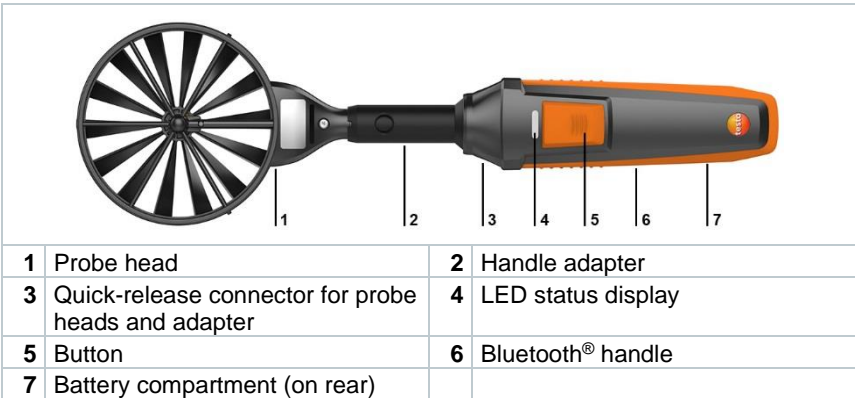

#### CAUTION



#### Damage to sensor possible!

- Do not touch sensor!



The testovent bracket included in the package is intended for the testovent 417 measurement funnel.

#### Connect vane probe (Ø 100 mm) to the handle

- Turn quick-release connector, viewed from the handle end, through 90° anticlockwise until it locks in place.
 
- Insert handle adapter into the handle (pay attention to coding).
 
- Turn quick-release connector back through 90° until it locks in place.

- 4 Insert probe head into the handle adapter (pay attention to the guide groove and guide pin).



- 5 Push probe head in slightly and turn to lock in place.
- ▶ The vane probe is ready to use.



If necessary, the telescope (order no. 0554 0960) and the 90° angle (order no. 0554 0991) can be connected, e.g. for measurements at ceiling outlets.

### 3.6 High-precision temperature/humidity probe with Bluetooth® (0636 9771)

#### Application

In conjunction with the testo 440, the high-precision temperature/humidity probe is used to measure humidity and temperature.

#### Structure



1	Probe head	2	Quick-release connector
3	LED status display	4	Button
5	Bluetooth® handle	6	Battery compartment (on rear)

#### CAUTION

#### Damage to sensor possible!

- Do not touch sensor!

#### Connect high-precision temperature/humidity probe to the handle

- 1 Turn quick-release connector, viewed from the handle end, through 90° anticlockwise until it locks in place.
- 2 Insert probe head into the handle (pay attention to coding).



- 3 Turn quick-release connector back through 90° until it locks in place.
- ▶ The high-precision temperature/humidity probe is ready to use.

## 3.7 Temperature/humidity probe with Bluetooth® (0636 9731)

### Application

In conjunction with the testo 440, the temperature/humidity probe is used to measure humidity and temperature.

### Structure

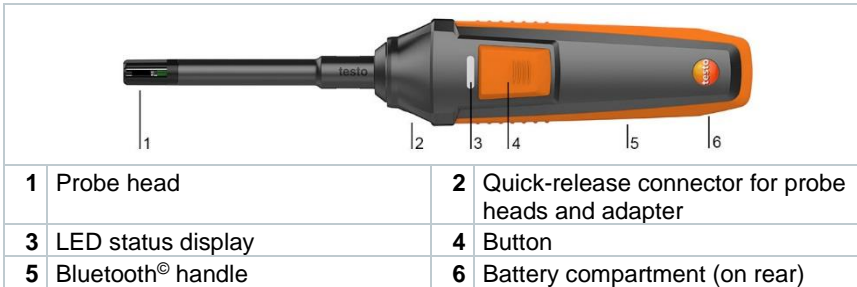

### CAUTION

#### Damage to sensor possible!

- Do not touch sensor!

### Connect temperature/humidity probe to the handle

- 1 Turn quick-release connector, viewed from the handle end, through 90° anticlockwise until it locks in place.
  - 2 Insert probe head into the handle (pay attention to coding).
  - 3 Turn quick-release connector back through 90° until it locks in place.
- ▶ The temperature/humidity probe is ready to use.





### 3.8 CO<sub>2</sub> probe with Bluetooth<sup>®</sup>, including temperature and humidity sensor (0632 1551)

#### Application

In conjunction with the testo 440, the CO<sub>2</sub> probe is used to determine CO<sub>2</sub> and to measure humidity and temperature.

#### Structure

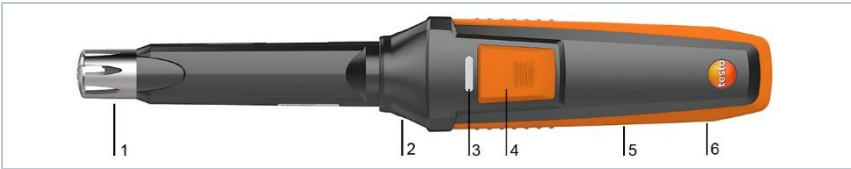

1	Probe head	2	Quick-release connector for probe heads and adapter
3	LED status display	4	Button
5	Bluetooth <sup>®</sup> handle	6	Battery compartment (on rear)

#### CAUTION

- The probe contains sensitive visual components. Please handle the probe with care.
- Strong vibrations alter the factory calibration. Checking of readings in fresh air 350 to 450 ppm CO<sub>2</sub> (urban air up to 700 ppm CO<sub>2</sub>).
- Avoid dew on the probe, otherwise long-term stability will be impaired. If there is dew on the probe, this can lead to higher CO<sub>2</sub> readings.
- If the ambient temperature changes (change of measuring location, e.g. indoors to outdoors or vice versa), the probe requires an acclimatization phase of a few minutes.
- After the instrument is switched on, there is a sensor warm-up phase of approx. 30 s.
- The CO<sub>2</sub> concentration in the sensor requires approx. 60 s to acclimatize to the environment. Gently waving the probe reduces the acclimatization time.
- Keep the probe as far away from your body as possible. This avoids any influences due to the CO<sub>2</sub> content of the air you breathe.

#### Connect CO<sub>2</sub> probe to the handle

- 1 Turn quick-release connector, viewed from the handle end, through 90° anticlockwise until it locks in place.
  - 2 Insert probe head into the handle (pay attention to coding).
  - 3 Turn quick-release connector back through 90° until it locks in place.
- ▶ The CO<sub>2</sub> probe is ready to use.



## 3.9 CO probe with Bluetooth® (0632 1271)

### Application

In conjunction with the testo 440, the CO probe is used to determine the CO concentration in the environment.

### Structure

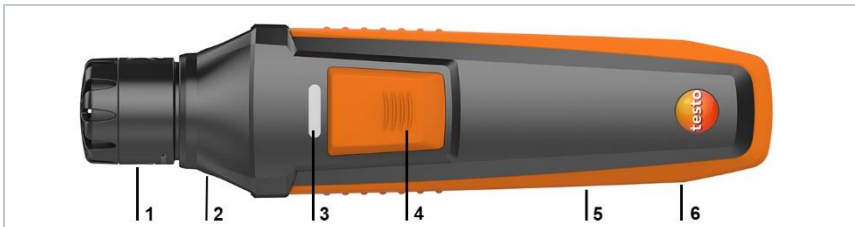

1	Probe head	2	Quick-release connector for probe heads and adapter
3	LED status display	4	Button
5	Bluetooth® handle	6	Battery compartment (on rear)

**⚠ DANGER**

#### Risk of death!

**Carbon monoxide is a colourless, odourless and tasteless gas. High concentrations can cause death.**

- Do not use the CO probe as a monitoring instrument for personal safety.

**Connect CO probe to the handle**

- 1 Turn quick-release connector, viewed from the handle end, through 90° anticlockwise until it locks in place.
  - 2 Insert probe head into the handle (pay attention to coding).
  - 3 Turn quick-release connector back through 90° until it locks in place.
- ▶ The CO probe is ready to use.



## 4 Commissioning

**Switching on**

- 1 - Press button on the handle.
- ▶ The handle is switched on.

**Switching off**

- 1 - Press and hold the button on the handle for three seconds.
- ▶ The handle is switched off.

**LED status display**

LED status display	Meaning
Flashing red	Low battery status
Flashing yellow	Measurement probe is switched on and is searching for a Bluetooth connection, but is not connected.
Flashing green	Measurement probe is switched on and Bluetooth is connected.

## 5 Maintenance

### Replacing the batteries

- 1 Open the battery compartment: push lock down and remove cover.



- 2 Take spent batteries out of the battery compartment and replace with new batteries (4 x AA type). Pay attention to polarity.

- 3 Put battery cover on and push lock back up.



- ▶ Handle is ready to use again.

## 5.1 Maintaining the probes

### 5.1.1 Cleaning the instrument



Do not use any aggressive cleaning agents or solvents; instead use mild household cleaning agents or soapy water.



Always keep the connections clean and free from grease and other deposits.

Clean the instrument and the connections with a damp cloth and dry them off.

### 5.1.2 Calibration



The probes are supplied with a factory calibration protocol as standard. Recalibration of the probes once every 12 months is recommended in many applications.

This can be carried out by Testo Industrial Services (TIS) or other certified service providers with the aid of easy-to-use service software. For calibration, the probe alone (without the hand instrument) can be sent away.

Please contact Testo for further information.

## 6 Questions and answers

Question	Possible cause / solution
LED status display flashes red	Batteries are almost empty. Change the batteries.
The probe switches itself off	Remaining battery capacity is too low. Change the batteries.

## 7 Technical data



- Adjustment conditions for flow probes:  
Adjustment in free jet Ø 350 mm, reference pressure 1013 hPa, based on testo reference Laser Doppler Anemometer (LDA).
- Note for flow probes:  
Low flow velocities may result in greater measurement uncertainties during humidity and temperature measurement!
- Note for humidity probes:  
Please do not use the humidity probes in condensing atmospheres.  
For continuous use in high-humidity ranges  
> 80% RH at ≤ 30°C for > 12 h  
> 60% RH at > 30°C for > 12 h  
please get in touch with Testo Service or contact us via the Testo website.

**Bluetooth® handle for connecting testo 440 probe heads (0554 1111)**

### Technical data

Feature	Value
Storage temperature	-10°C to +50°C
Operating temperature	0 to +50°C
Dimensions	170 mm x 50 mm x 40 mm
Warranty	Duration: 2 years Warranty terms: see <a href="http://www.testo.com/warranty">www.testo.com/warranty</a> website.

**Hot wire probe with Bluetooth<sup>®</sup>, including temperature and humidity sensor (0635 1571)**

Feature	Value
Measuring range	0 to +50 m/s -20 to +70°C 5 to 95% RH 700 to 1100 hPa
Accuracy (at 22°C, ±1 digit)	±(0.03 m/s + 4% of m.v.) (0 to 20 m/s) ±(0.5 m/s + 5% of m.v.) (20.01 to 30 m/s) ±0.8°C (-20 to 0°C) ±0.5°C (0 to +70°C) ±3 hPa
Accuracy (at 25°C, ±1 digit)	±3.0% RH (10 to 35% RH) ±2.0% RH (35 to 65% RH) ±3.0% RH (65 to 90% RH) ±5% RH (remaining measuring range) Additional uncertainty: - Hysteresis: ±1.0% RH - Long-term stability: ±1% RH / year
Resolution	0.01 m/s 0.1°C 0.1% RH 0.1 hPa
Temperature coefficient	type (k=1) 0.06% RH/K
Storage temperature	-20 to +60°C
Operating temperature	-5 to +50°C
Bluetooth <sup>®</sup> range	20 m (free field)
Battery life	21.5 h
Probe head length	230 mm
Ø probe head on the sensor	9 mm
Dimensions of probe head with telescope	Extension length: 1000 mm Probe length from handle end to probe head end with retracted telescope: 800 mm
Directives, standards and tests	EU directive: 2014/30/EU

**Vane probe (Ø 16 mm) with Bluetooth®, including temperature sensor (0635 9571)**

Feature	Value
Measuring range	0.6 to 50 m/s -10 to +70°C
Accuracy (at 22°C, ±1 digit)	±(0.2 m/s + 1% of m.v.) (0.6 to 40 m/s) ±(0.2 m/s + 2% of m.v.) (40.1 to 50 m/s) ±1.8°C
Resolution	0.1 m/s 0.1°C
Storage temperature	-20 to +60°C
Operating temperature	-5 to +50°C
Bluetooth® range	20 m (free field)
Battery life	70 h
Dimensions	790 mm x 50 mm x 40 mm
Probe head length	230 mm
Ø probe head	16 mm
Dimensions of probe head with telescope	Extension length: 1000 mm Probe length from handle end to probe head end with retracted telescope: 800 mm
Directives, standards and tests	EU directive: 2014/30/EU

**High-precision vane probe (Ø 100 mm) with Bluetooth®, including temperature sensor (0635 9371)**

Feature	Value
Measuring range	0.1 to 15 m/s -20 to 70°C
Accuracy (at 22°C, ±1 digit)	±(0.1 m/s + 1.5% of m.v.) (0.1 to 15 m/s) ±0.5°C
Resolution	0.01 m/s 0.1°C
Storage temperature	-20 to +60°C
Operating temperature	-5 to +50°C
Bluetooth® range	20 m (free field)
Battery life	60 h
Dimensions	375 mm x 105 mm x 46 mm
Ø vane	100 mm
Directives, standards and tests	EU directive: 2014/30/EU

**Vane probe (Ø 100 mm) with Bluetooth®, including temperature sensor (0635 9431)**

Feature	Value
Measuring range	0.3 to 35 m/s -20 to 70°C
Accuracy (at 22°C, ±1 digit)	±(0.1 m/s + 1.5% of m.v.) (0.3 to 20 m/s) ±(0.2 m/s + 1.5% of m.v.) (20.01 to 35 m/s) ±0.5°C ±0.5°C (-20 to 0°C)
Resolution	0.01 m/s 0.1°C
Storage temperature	-20 to +60°C
Operating temperature	-5 to +50°C
Bluetooth® range	20 m (free field)
Battery life	60 h
Dimensions	375 mm x 105 mm x 46 mm
Ø vane	100 mm
Directives, standards and tests	EU directive: 2014/30/EU

**High-precision temperature/humidity probe with Bluetooth® (0636 9771)**

Feature	Value
Measuring range	-20 to 70°C 0 to 100% RH
Accuracy (at 22°C, ±1 digit)	±0.3°C (15 to 30°C), ±0.5°C remaining measuring range
Accuracy (at 25°C, ±1 digit)	±(0.6% RH + 0.7% of m.v.) (0 to 90% RH) ±(1.0% RH + 0.7% of m.v.) (90 to 100% RH) Additional uncertainty: - Hysteresis: ±0.4 %RH - Long-term stability: ±1% RH / year
Resolution	0.01°C 0.01% RH
Temperature coefficient	type (k=1) ±0.03% RH/K
Storage temperature	-20 to +60°C
Operating temperature	-5 to +50°C
Bluetooth® range	20 m (free field)
Battery life	140 h
Dimensions	295 mm x 50 mm x 40 mm
Probe head length	140 mm



Feature	Value
Ø probe head	Ø 12 mm
Directives, standards and tests	EU directive: 2014/30/EU

### Temperature/humidity probe with Bluetooth® (0636 9731)

Feature	Value
Measuring range	-20 to +70°C 0 to 100% RH
Temperature accuracy (at 22°C ±1 digit)	±0.5°C
Humidity accuracy (at 25°C ±1 digit)	±2% RH (5 to 90% RH) Additional uncertainty: - Long-term stability: ±1% RH / year
Resolution	0.1°C 0.1% RH
Temperature coefficient	type (k=1) ±0.03% RH/K
Storage temperature	-20°C to +60°C
Operating temperature	-5°C to +50°C
Bluetooth® range	20 m (free field)
Battery life	140 h
Dimensions	295 mm x 50 mm x 40 mm
Ø probe head	12 mm
Directives, standards and tests	EU directive: 2014/30/EU

### CO2 probe with Bluetooth®, including temperature and humidity sensor (0632 1551)

Feature	Value
Measuring range	0 to +50°C 5 to 95% RH 0 to 10,000 ppm CO2 700 to 1100 hPa
Accuracy (at 22°C, ±1 digit)	±0.5°C ±(50 ppm + 3% of m.v.) (0 to 5,000 ppm) ±(100 ppm + 5% of m.v.) (5,001 to 10,000 ppm) ±3 hPa

## 7 Technical data

Feature	Value
Accuracy (at 25°C, ±1 digit)	±3.0% RH (10 to 35% RH) ±2.0% RH (35 to 65% RH) ±3.0% RH (65 to 90% RH) ±5% RH (remaining range) Additional uncertainty: - Hysteresis: ±1% RH - Long-term stability: ±1% RH / year
Resolution	0.1°C 0.1% RH 1 ppm 0.1 hPa
Temperature coefficient	type (k=1) 0.06% RH/K (0 to +50°C) ±(2 ppm + 0.4% of m.v.) / K
Storage temperature	-20°C to +60°C
Operating temperature	-5°C to +50°C
Bluetooth® range	20 m (free field)
Battery life	21.5 h
Dimensions	290 mm x 50 mm x 40 mm
Ø probe head	21 mm
Directives, standards and tests	EU directive: 2014/30/EU

### CO probe with Bluetooth® (0632 1271)

Feature	Value
Measuring range	0 to 500 ppm
Accuracy (at 22°C, ±1 digit)	±3 ppm (0 to 30 ppm) ±10% of m.v. (30.1 to 500 ppm)
Resolution	0.1 ppm
Storage temperature	-20 to +50°C / recommended: -10 to +30°C
Operating temperature	-5 to +50°C
Bluetooth® range	20 m (free field)
Battery life	70 h
Dimensions	195 mm x 50 mm x 40 mm
Ø probe head	30 mm
Directives, standards and tests	EU directive: 2014/30/EU

## 8 Accessories and spare parts

Description	Order no.
Hot wire probe head, including temperature and humidity sensor	0635 1570
16 mm vane probe head, including temperature sensor	0635 9570
High-precision 100 mm vane probe head, including temperature sensor	0635 9370
100 mm vane probe head	0635 9430
High-precision temperature/humidity probe head	0636 9770
Temperature/humidity probe head	0636 9730
CO <sub>2</sub> probe head, including temperature and humidity sensor	0632 1550
CO probe head	0632 1270
Bluetooth® handle for connecting testo 440 probe heads	0554 1111
Handle adapter for connecting testo 440 flow probes	0554 2160
Measuring stand for comfort level measurements with standard-compliant positioning of probes (including bag)	0554 1590
Extendable telescope for testo 440 flow probes, including 90° angle	0554 0960
Telescope extension (length 0.40 to 0.85 m) for testo 440 flow probes	0554 0990
90° angle for connecting the testo 440 vane probe (Ø 100 mm)	0554 0991
Combi-case for testo 440 and multiple probes	0516 4401



**Testo SE & Co. KGaA**

Celsiusstraße 2

79822 Titisee-Neustadt

Germany

Telefon: +49 7653 681-0

E-Mail: [info@testo.de](mailto:info@testo.de)

Internet: [www.testo.com](http://www.testo.com)