



testo 330 · Flue gas analyzer

Instruction manual





Register your Testo product at www.testo.com/register and receive a one-year free warranty extension.

The product registration is valid for 30 days after purchase.

For product registration terms and conditions and participating countries, please go to www.testo.com/register

1 Contents

1	Contents	3
2	Safety and the environment	6
	2.1. About this document.....	6
	2.2. Ensure safety.....	7
	2.3. Product-specific safety instructions	9
	2.4. Protecting the environment.....	9
3	Specifications	10
	3.1. Use	10
	3.2. Technical data	11
	3.2.1. Examinations and licenses	11
	3.2.2. Measuring ranges and resolution.....	11
	3.2.3. Accuracy and response time	13
	3.2.4. Other instrument data.....	14
4	Product description	16
	4.1. Case 0516 3300 (accessory).....	16
	4.1.1. Bottom level view	16
	4.1.2. Top level view.....	17
	4.2. Case 0516 3301 (accessory).....	18
	4.2.1. Bottom level view	18
	4.2.2. Middle level view	19
	4.2.3. Top level view.....	20
	4.3. Measuring instrument	21
	4.3.1. Overview	21
	4.3.2. Keypad	22
	4.3.3. Display.....	23
	4.3.4. Device connections.....	24
	4.3.5. Interfaces	24
	4.3.6. Components	25
	4.3.7. Carrying strap (0440 1001).....	26
	4.4. Modular flue gas probe	27
5	First steps	28
	5.1. Commissioning	28
	5.2. Getting to know the product.....	28
	5.2.1. Mains unit / rechargeable battery.....	28
	5.2.1.1. Changing the battery	28
	5.2.1.2. Charging batteries	29
	5.2.1.3. Mains operation	29
	5.2.2. Connecting probes / sensors.....	30

5.2.3.	Switching on	31
5.2.4.	Calling up a function	31
5.2.5.	Entering values	31
5.2.6.	Show graphic	32
5.2.7.	Printing / saving data	33
5.2.8.	Remembering data (clipboard)	33
5.2.9.	Confirming an error message	33
5.2.10.	Switching off	34
5.3.	Address/Location	34
5.4.	Measurement records	36
5.5.	Instrument diagnosis	37
6	Using the product	38
6.1.	Performing settings	38
6.1.1.	Assigning the right function key	38
6.1.2.	Instrument settings	38
6.1.2.1.	Readings display	38
6.1.2.2.	Alarm limits	40
6.1.2.3.	Units	40
6.1.2.4.	Date / time	40
6.1.2.5.	Energy management	41
6.1.2.6.	Display brightness	41
6.1.2.1.	Choose measurement type	41
6.1.2.2.	Printer	42
6.1.2.3.	Bluetooth®	42
6.1.2.4.	Language	42
6.1.2.5.	Country version	43
6.1.2.6.	Password protection	43
6.1.3.	Sensor settings	44
6.1.3.1.	NO ₂ addition	44
6.1.3.2.	O ₂ reference	44
6.1.3.3.	Sensor protection	45
6.1.3.4.	Recalibration / adjustment	45
6.1.4.	Fuels	46
6.1.5.	Programs	47
6.2.	Measuring	48
6.2.1.	Preparing for measurement	48
6.2.1.1.	Zeroing phases	48
6.2.1.2.	Using the modular flue gas probe	49
6.2.1.3.	Configuring the reading display	50
6.2.1.4.	Setting location and fuel	50
6.2.2.	Flue gas	50
6.2.3.	Draught-Measurement	52
6.2.4.	Micro pressure probe	53
6.2.5.	BlmSchV (testo 330-2 LL)	54
6.2.6.	CO undiluted	55
6.2.7.	Smoke No. / HCT	55

6.2.8.	Differential pressure.....	56
6.2.9.	Differential temperature.....	57
6.2.10.	O2 air.....	57
6.2.11.	Gas flow.....	58
6.2.12.	Oil flow.....	59
6.2.13.	CO ambient.....	59
6.2.14.	CO2 ambient.....	60
6.2.15.	Automatic furnaces.....	61
6.2.16.	Solid fuel measurement.....	62
6.2.17.	Gas pipe tests.....	63
	6.2.17.1. Tightness test 1.....	63
	6.2.17.2. Tightness test 2.....	64
	6.2.17.3. Let By Test.....	65
	6.2.17.4. Leak detection.....	66
6.3.	Transferring data.....	66
	6.3.1. Report printer.....	66
	6.3.2. PC / Pocket PC.....	67
7	Maintaining the product.....	68
	7.1. Cleaning the measuring instrument.....	68
	7.2. Replacing sensors.....	68
	7.3. Recalibrating / adjusting sensors.....	69
	7.4. Replacing additional filter.....	69
	7.5. Cleaning the modular flue gas probe.....	70
	7.6. Replacing the probe module.....	70
	7.7. Changing the thermocouple.....	71
	7.8. Condensate container.....	72
	7.9. Checking / replacing the particle filter.....	73
8	Tips and assistance.....	74
	8.1. Questions and answers.....	74
	8.2. Accessories and spare parts.....	75
	8.3. Updating the instrument software.....	79

2 Safety and the environment



2.1. About this document

This document describes the products testo 330-1 LL and testo 330-2 LL with the instrument setting **Country version | Germany**.

Use

- > Please read this documentation through carefully and familiarize yourself with the product before putting it to use. Pay particular attention to the safety instructions and warning advice in order to prevent injuries and damage to the products.
- > Keep this document to hand so that you can refer to it when necessary.
- > Hand this documentation on to any subsequent users of the product.

Symbols and writing standards

Representation	Explanation
	Warning advice, risk level according to the signal word: Warning! Serious physical injury may occur. Caution! Minor physical injury or damage to the equipment may occur. > Apply the specified precautionary measures.
	Note: Basic or further information.
testo 330-1 LL	The description only applies for the specified instrument model testo 330-1 LL or testo 330-2 LL.
1. ...	Action: several steps, the sequence must be followed.
2. ...	
> ...	Action: one step or optional step.
- ...	Result of an action.
Menu	Elements of equipment , equipment display or program interface.

Representation	Explanation
[OK]	Control keys on equipment or control buttons in program interface.
... ...	Functions / paths within a menu.
“...”	Example entries

2.2. Ensure safety

- > Only operate the product properly, for its intended purpose and within the parameters specified in the technical data. Do not use any force.
- > Do not operate the instrument if there are signs of damage at the housing, mains unit or feed lines.
- > Do not perform contact measurements on non-insulated, live parts.
- > Do not store the product together with solvents. Do not use any desiccants.
- > Carry out only the maintenance and repair work on this instrument that is described in the documentation. Follow the prescribed steps exactly. Use only original spare parts from Testo.
- > Any further or additional work must only be carried out by authorised personnel. Testo will otherwise refuse to accept responsibility for the proper functioning of the measuring instrument after repair and for the validity of certifications.
- > Only use the device in closed, dry rooms and protect it from rain and moisture.
- > Temperatures given on probes/sensors relate only to the measuring range of the sensors. Do not expose handles and feed lines to any temperatures in excess of 70 °C unless they are expressly permitted for higher temperatures.
- > The testo 330 must be checked before commissioning for any visible damage. Do not commission the testo 330 if there are signs of damage on the housing, mains unit or supply lines. Electrical risk.
- > Dangers may also arise from the systems being measured or the measuring environment: Note the safety regulations valid in your area when performing the measurements.



Use distilled water, or alternatively mild solvents such as isopropanol to clean the flue gas analyzer. If using

isopropanol, please refer to the instruction leaflet for the product. Isopropanol fumes have a slight narcotic effect, and typically cause irritation of the eyes and sensitive mucous membranes. When using it, please ensure that there is adequate ventilation.

i Do not store any objects that have come into contact with solvents and/or degreasers (e.g. isopropanol) in the case. Evaporating or leaking solvents and/or degreasers may cause damage to the instrument and to the sensors.

i The use of strong or harsh alcohol or brake cleaner can result in damage to the instrument.

For products with Bluetooth® (optional)

Changes or modifications that have been made without the explicit consent of the responsible approval authority, may cause the retraction of the type approval.

Data transfer may be disturbed by equipment that uses the same ISM-band, e.g. WLAN, microwave ovens, ZigBee.

The use of radio communication links is not permitted, among others, in aeroplanes and hospitals. For this reason the following points must be ensured before entering:

- > Switch off the device:
- > Isolate the device from any external power sources (mains cable, external rechargeable batteries, ...).

2.3. Product-specific safety instructions

CAUTION

Acid in the sensors.

May cause chemical burns.

- > Do not open the sensors.
Eye contact: Rinse the affected eye thoroughly under running water for 10 minutes, keeping the eyelids wide open and protecting the unaffected eye. Remove contact lenses wherever possible.

CAUTION

Powder in the sensor filters.

May cause irritation to the skin, eyes or respiratory tract.

- > Do not open the sensor filters.
Eye contact: Rinse the affected eye thoroughly under running water for 10 minutes, keeping the eyelids wide open and protecting the unaffected eye. Remove contact lenses wherever possible.
Skin contact: Remove the injured person's contaminated clothing, ensuring self-protection. Rinse affected skin areas under running water for at least 10 minutes.
Inhalation: Move to fresh air and make sure that breathing is unrestricted.
Ingestion: Rinse mouth out and spit out liquid. If conscious, drink 1 glass of water (approx. 200 ml). Do not induce vomiting.

2.4. Protecting the environment

- > Dispose of faulty rechargeable batteries/spent batteries in accordance with the valid legal specifications.
- > At the end of its useful life, send the product to the separate collection for electric and electronic devices (observe local regulations) or return the product to Testo for disposal.
- > The button cell used in the instrument contains 1,2-Dimethoxyethane (CAS 110-71-4). See EC Regulation No. 1907/2006 (REACH) Art. 33.

3 Specifications

3.1. Use

The testo 330 is a handheld measuring device for the professional flue gas analysis of furnace systems:

- Small furnaces (burning oil, gas, wood, coal)

i The solid fuel measurement adapter (0600 9765) is required for measurements on solid fuel systems. The adapter protects the measuring instrument from harmful substances (dust, organic compounds, etc.).

- Low-temperature and condensing boilers
- Gas water heaters

These systems can be adjusted using the testo 330 and checked for compliance with the applicable limit values.

The following tasks can also be carried out with the testo 330:

- Regulating the O₂-, CO- and CO₂-, NO-, NO_x- values in furnace systems for the purpose of ensuring optimal operation.
- Draught measurement.
- Measuring and regulating the gas flow pressure in gas water heaters.
- Measuring and optimising the flow and return temperatures of heating systems.
- CO and CO₂ environment measurement.
- Detection of CH₄ (methane) and C₃H₈ (propane).
- The testo 330 can be used for measurements on CHP stations in accordance with the first German Federal Immission Control Ordinance (BImSchV).
 - In principal, the CO sensor can also be used for measurements on CHP stations. If you should carry out more than 50 measurements on CHP stations per year, please contact your nearest testo service centre or send the testo 330 for checking to testo Service.

A worn NO_x filter of the CO sensor can be ordered as a spare part (order no. 0554 4150) and replaced.

i Testo guarantees the functionality of its products when used in accordance with their intended purpose. This guarantee does not apply to features of Testo products in combination with unauthorised third-party products. Competitor products are not authorised by Testo. As is common practice, Testo generally excludes support, warranty or guarantee claims relating to functionality that

has not been guaranteed by Testo as part of the product offered. Claims shall also be excluded in the event of improper use or handling of the products, e.g. in combination with unauthorised third-party products.

testo 330 must not be used:

- as a safety (alarm) instrument
-



testo 330 with Bluetooth® option:

The use of the wireless module is subject to the regulations and stipulations of the respective country of use, and the module may only be used in countries for which a country certification has been granted. The user and every owner has the obligation to adhere to these regulations and prerequisites for use, and acknowledges that the re-sale, export, import etc. in particular in countries without wireless permits, is his responsibility.

3.2. Technical data

3.2.1. Examinations and licenses

Testo SE & Co. KGaA hereby declares that the testo 330-1 LL and testo 330-2 LL (0632 3306, 0632 3307) comply with Directive 2014/53/EU.

The full text of the EU Declaration of Conformity can be found on the following website: <https://www.testo.com/eu-conformity>.

3.2.2. Measuring ranges and resolution

Parameter	Measuring range	Resolution
O ₂	0...21 Vol. %	0.1 vol. %
CO	0...4000 ppm	1 ppm
CO, H ₂ -comp. ¹	0...8000 ppm	1 ppm
COlow	0...500 ppm	0.1ppm
AmbCO through flue gas probe	0...2000 ppm	1 ppm

¹ above the sensor protection threshold: Resolution 1 ppm (up to max. 30,000 ppm)

3 Specifications

Parameter	Measuring range	Resolution
AmbCO with probe 0632 3331	0...500 ppm	1 ppm
NO	0...3000 ppm	1 ppm
NOlow	0...300 ppm	0.1 ppm
Draught	-9.99...40 hPa	0.01 hPa
ΔP	0...300 hPa	0.1 hPa
Temperature	-40...1200 °C	0.1°C (-40.0...999.9 °C) 1°C (rest of range)
Efficiency net	0...120 %	0.1 %
Flue gas loss	0...99.9 %	0.1 %
AmbCO ₂ with probe 0632 1240	0...1 vol. 0...10000 ppm	-
Gas leak testing with probe 0632 3330	0...10000 ppm CH ₄ / C ₃ H ₈	-

3.2.3. Accuracy and response time

Parameter	Accuracy	Response time
O ₂	±0.2 vol. %	< 20s (t ₉₀)
CO	±20 ppm (0...400 ppm) ±5% of mv (401...2000 ppm) ±10% of mv (2001...4000 ppm)	< 60s (t ₉₀)
CO, H ₂ -comp.	±10 ppm or ±10 % of mv ² (0...200 ppm) ±20 ppm or ±5 % of mv ² (201...2000 ppm) ±10% of mv (2001...8000 ppm) only testo 330-2: 8000...30000 ppm (automatic dilution)	< 60s (t ₉₀)
COlow	±2 ppm (0...39.9 ppm) ±5 % of mv (rest of range)	< 40s (t ₉₀)
AmbCO through flue gas probe	±10 ppm (0...100 ppm) ±10 % of mv (101....2000 ppm)	< 35s (t ₉₀)
AmbCO with 0632 3331	±5 ppm (0...100 ppm) ³ ±5 % of mv (>101 ppm)	approx. 35s (t ₉₀)
NO	±2 ppm (0...39,9 ppm) ±5 % of mv (40....2000 ppm) ±10 % of mv (2001...3000 ppm)	< 30s (t ₉₀)
NOlow	±2 ppm (0...39,9 ppm) ±5% of mv (rest of range)	< 30s (t ₉₀)
Draught ⁴	±0.02 ppm or ±5% of mv ² (-0.50...0.60 hPa) ± 0.03 hPa (0.61...3.00 hPa) ±1.5 % of mv (3.01...40.00 hPa)	-

² higher value is valid

³ at 10...30 °C, outside this range additionally ±0.2 % of mv / °C

⁴ with fine draught measurement option: Measuring range 0...100, 0Pa, resolution 0.1Pa

Parameter	Accuracy	Response time
ΔP	± 0.5 hPa (0.0...50.0 hPa) ± 1 % of mv (50.1...100.0 hPa) ± 1.5 % of mv (rest of range)	-
Temperature	± 0.5 °C (0.0...100.0 °C) ± 0.5 % of mv (rest of range)	probe dependent
Efficiency	-	-
Flue gas loss	-	-
AmbCO ₂ , through 0632 1240	± 75 ppm + 3 % of mv (0...5000 ppm) ± 150 ppm + 5 % of mv (5001...10000 ppm)	approx. 35s (t ₉₀)
Gas leak testing with 0632 3330	-	< 2s (t ₉₀)

3.2.4. Other instrument data

Flue gas analyser

Characteristic	Values
Storage / and transport temperature	-20...50 °C
Operating temperature	-5...45 °C
Ambient humidity	0...90 % rH, not condensing
Power supply	Battery: 3.7 V / 2.6 Ah Mains unit: 6 V/1.2 A
Protection class	IP40
Weight	600 g (excluding battery)
Dimensions	270 x 90 x 65 mm
Memory	500,000 readings
Display	Graphic colour display, 240 x 320 pixels
Flue gas overpressure	max. 50 mbar
Negative pressure	max. 80 mbar

Characteristic	Values
Gas leak testing probe	visual indication (LED) audible indication by buzzer
Storage temperature battery	$\pm 0 \dots 35$ °C
Battery charge time	approx. 5-6 h
Battery operation time	6h (pump on, 20 °C ambient temperature)
Bluetooth® (option)	Range < 10 m
Warranty	Measuring instrument: 48 months LL-sensors O ₂ , CO: 48 months NOlow sensor: 12 months Other sensors: 24 months Flue gas probe: 48 months Thermocouple: 12 months Battery: 12 months Further warranty terms: see website www.testo.com/warranty

4 Product description

4.1. Case 0516 3300 (accessory)

Recommended for stowing away the measuring instrument and accessories (example)

4.1.1. Bottom level view



- 1 Sealing clip
- 2 testo 330-1 /-2 LL flue gas analyzer
- 3 Repository for printer accessories
 - Spare batteries for IRDA printer
 - 1 roll of spare thermal paper (0554 0568)
- 4
- 5
- 6
- 6
- 7
- 8
- 9

- 4 Repository for printer
 - IRDA printer (0554 0549)
 - Bluetooth®/IRDA printer (0554 0620)
5. Instruction manual
- 6 Lock
- 7 Probes
 - Flue gas probe (e.g. 0600 9741)
- 8 Large storage compartment
 - Mains unit for testo 330-1 /-2 LL (0554 1096)
 - Differential temperature set (0554 1208)
 - Spare dirt filter (0554 0040)
- 9 Round storage compartment
 - Hose connection set with pressure adapter (0554 1203)

4.1.2. Top level view

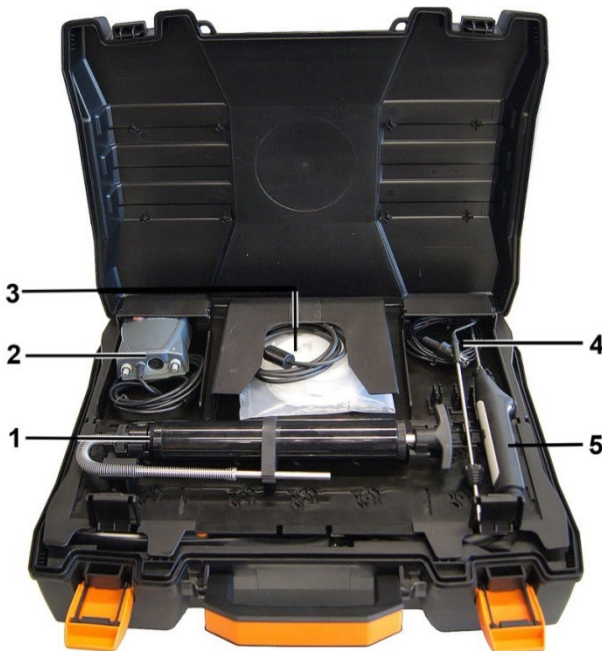

- 1 Soot pump set (0554 0307)
- 2 Storage compartment
 - Fine pressure probe (0638 0330)
- 3 Storage compartment

- Capillary hose set for fine pressure probe (0554 1215)
 - Connecting cable for surface probe (0430 1215)
4. Combustion air temperature probe (0600 9787)
 5. Surface temperature probe Type K (0604 0994)

4.2. Case 0516 3301 (accessory)

Recommended for stowing away the measuring instrument and accessories (example)

4.2.1. Bottom level view



- 1 Fine pressure probe (0638 0330)
- 2 testo 308 smoke tester (0632 0308)

4.2.2. Middle level view



- 1 Sealing clip
- 2 testo 330-1 /-2 LL flue gas analyzer
- 3 Repository for printer accessories
 - Spare batteries for IRDA printer
 - 1 roll of spare thermal paper (0554 0568)
- 4 Repository for printer
 - IRDA printer (0554 0549)
 - Bluetooth® /IRDA printer (0554 0620)
5. Instruction manual
- 6 Lock
- 7 Probes
 - Flue gas probe (e.g. 0600 9741)
- 8 Large storage compartment

- Mains unit for testo 330-1 /-2 LL (0554 1096)
 - Differential temperature set (0554 1208)
 - Spare dirt filter (0554 0040)
- 9 Round storage compartment
- Hose connection set with pressure adapter (0554 1203)

4.2.3. Top level view

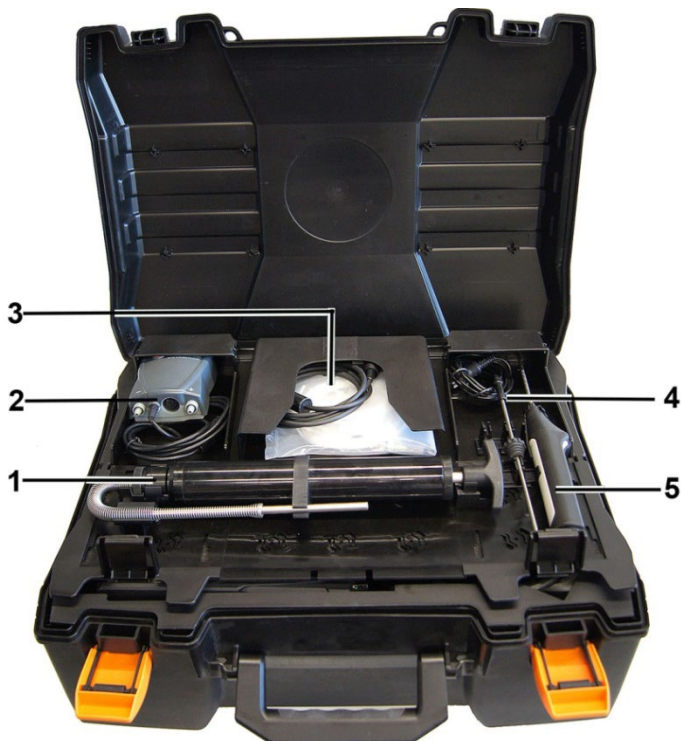

- 1 Soot pump set (0554 0307)
- 2 Storage compartment
 - Fine pressure probe (0638 0330)
- 3 Storage compartment
 - Capillary hose set for fine pressure probe (0554 1215)
 - Connecting cable for surface probe (0430 1215)
- 4 Combustion air temperature probe (0600 9787)
5. Surface temperature probe Type K (0604 0994)

4.3. Measuring instrument

4.3.1. Overview



- 1 Switch on/off
- 2 Interfaces: USB, PS2 (for devices until 2017), infrared

⚠ CAUTION

Risk of injury from infrared beam!

- > Do not direct infrared beam at human eyes!

- 3 Condensate trap (on rear)
- 4 Fixing eyelets for carrying strap (left and right)
- 5 Display

6 Magnetic holders (on rear)

WARNING

Magnetic field

May be harmful to those with pacemakers.

- > Keep a minimum distance of 15 cm between pacemaker and instrument.

ATTENTION

Magnetic field

Damage to other devices!

- > Keep a safe distance away from products which could be damaged by the effects of magnetism (e.g. monitors, computers or credit cards).









7 Keypad

8 Service cover (on rear)

9 Gas outlet

10 Unit connections: flue gas probe, sensor, pressure probe, mains unit



4.3.2. Keypad

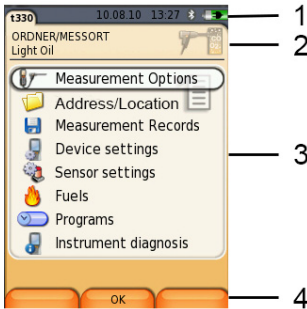

Key	Functions
	Switch measuring instrument on / off
 Example	Function key (orange, 3x), relevant function is shown on the display
	Scroll up, increase value
	Scroll down, reduce value
	Back, cancel function
	Open main menu
	Open instrument diagnosis menu
	Transmit data to the Testo protocol printer.

4.3.3. Display



1 Status bar (dark grey background):

- Warning symbol  (only if there is a device error, display of error in instrument diagnosis menu), otherwise: Instrument designation.
- Symbol  (only if data are stored in the temporary memory).
- Display of date and time.
- Indication of Bluetooth® status, power supply and remaining capacity of the battery:

Icon	Feature
	blue symbol = Bluetooth® on, grey symbol = Bluetooth® off
	Battery operation Indication of remaining capacity of the rech. batt. by colour and filling degree of the battery symbol (green = 5-100 %, red = < 5 %)
	Mains operation Indication of remaining capacity of battery: see above

- 2 Info field of register tabs: Indication of selected Address / Location, chosen fuel, chosen measurement type
- 3 Selection field for functions (chosen function appears against a white background, unavailable functions are identified by grey characters) or display of measuring values.
- 4 Function display for function keys.

4.3.4. Device connections

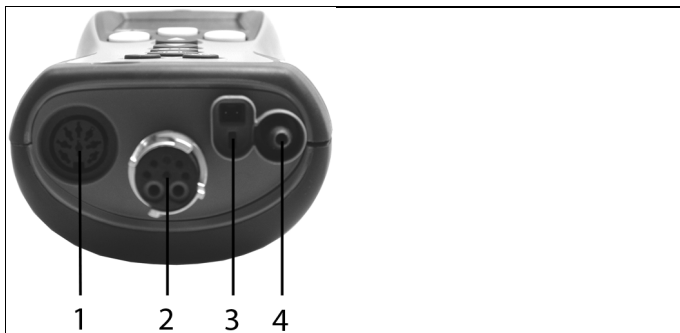

- 1 Probe socket
- 2 Flue gas socket
- 3 Mains unit socket
- 4 Pressure socket

4.3.5. Interfaces

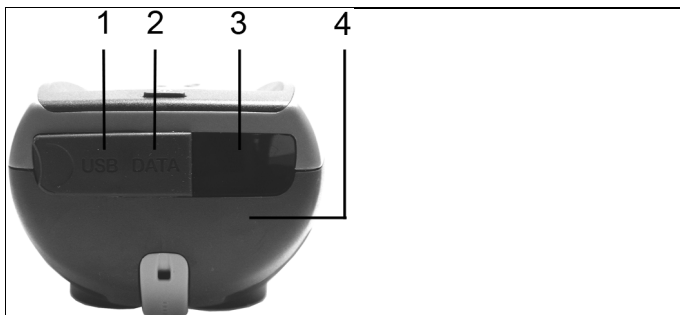

- 1 USB interface
- 2 PS2-interface (for devices until 2017)
- 3 Infrared interface (IrDA)
- 4 Bluetooth interface (optional)

4.3.6. Components

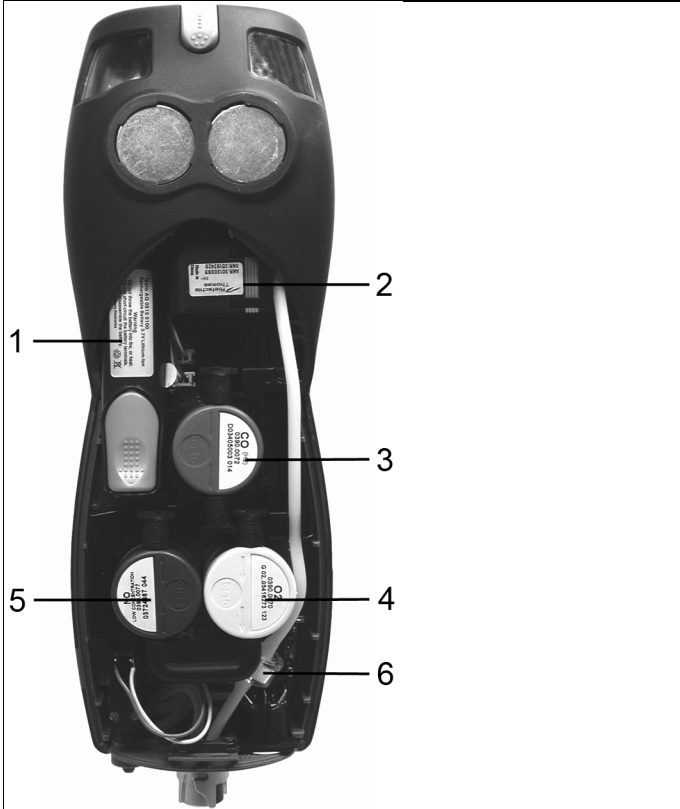

- 1 Rechargeable battery
- 2 Measuring gas pump
- 3 Slot for CO-sensor or COlow-sensor
- 4 Slot O2-sensor
- 5 Slot NO-sensor or NOlow-sensor
- 6 Additional filter

4.3.7. Carrying strap (0440 1001)

To secure the carrying strap:

- > Remove the sealing caps from the sides of the housing.

Fix the sealing caps on the inside of the service cover:

1. Place the measuring instrument on its front.
2. Pick the service cover up at the markings (arrows) using your index finger and thumb and press gently to release the lock.
3. Fold up the service cover and remove it.

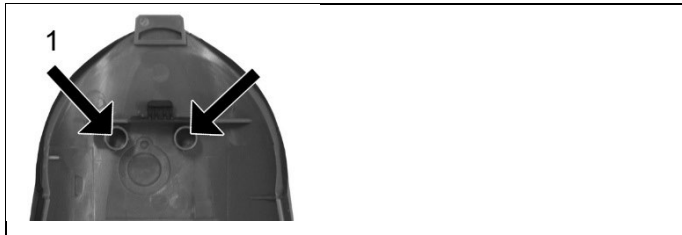

4. Secure the sealing caps in the two holders on the inside of the service cover (1).
5. Attach the service cover and engage it in place.



- > Engage the carrying strap clip in the fixing eyelets on the sides of the device. Note the guide groove, the strap must point "down" (2).

4.4. Modular flue gas probe

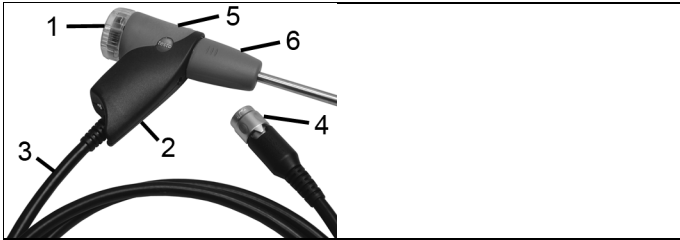

- 1 Removable filter chamber with window and particle filter
- 2 Probe handle
- 3 Connecting cable
- 4 Connector plug for measuring instrument
- 5 Probe module lock release
- 6 Probe module

5 First steps

5.1. Commissioning

The measuring instrument is supplied with a rechargeable battery already fitted.

- > Charge the battery fully before using the measuring instrument, see Charging batteries, page 29.

5.2. Getting to know the product

5.2.1. Mains unit / rechargeable battery

If the mains unit is connected, the measuring instrument is automatically powered from the unit.

5.2.1.1. Changing the battery

- ✓ The measuring instrument must not be connected to a mains socket via the mains unit. The instrument must be switched off.

Change the rechargeable battery within 3 minutes so that device settings (e.g. date / time) are not lost.

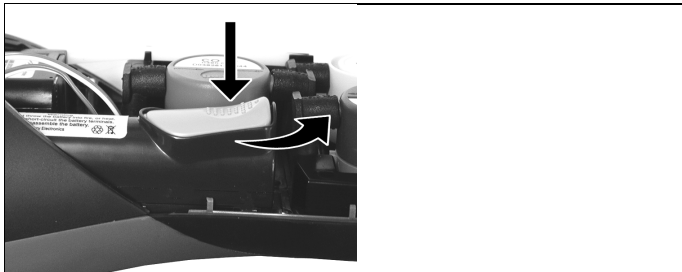

1. Place the measuring instrument on its front.
2. Remove the service cover: Take hold of it at the markings (arrows) using the index finger and thumb, press slightly, fold up and remove.
3. Open the battery lock: Press the grey key and push in direction of arrow.
4. Remove the battery and insert a new rechargeable battery. Only use the Testo rechargeable battery 0515 0107!
5. Close the battery lock: Press the grey key and push against direction of arrow until the battery engages.
6. Attach the service cover and engage it in place.

5.2.1.2. Charging batteries

The rechargeable battery can only be charged at an ambient temperature of $\pm 0 \dots +35$ °C. If the battery has been discharged completely, the charging time at room temperature is approx. 5-6 hrs.

Charging in the measuring instrument

1. Connect the plug of the mains unit to the mains unit socket on the measuring instrument.
2. Connect the mains plug of the mains unit to a mains socket.
 - The charging process will start. The charge condition will be shown in the display. The charging process will stop automatically when the battery is fully charged.

Charging in the charging station (0554 1087)

- > Refer to the documentation enclosed with the charging station.

Battery care

- > Do not fully exhaust rechargeable batteries.
- > Store rechargeable batteries only in charged condition and at low temperatures, but not below 0 °C (best storage conditions with a charge level of 50-80 %, at an ambient temperature of 10-20 °C, recharge completely before use).
- > For longer breaks you should discharge and recharge the batteries every 3- months. Trickle charging should not exceed 2 days.

5.2.1.3. Mains operation

1. Connect the plug of the mains unit to the mains unit socket on the measuring instrument.
2. Connect the mains plug of the mains unit to a mains socket.
 - The measuring instrument is powered by the mains unit.
 - If the measuring instrument is switched off and a rechargeable battery is inserted, the charging process will start automatically. Switching the measuring instrument on has the effect of stopping battery charging and the measuring instrument is then powered via the mains unit.



For longer measurements that are mains-operated, Testo recommends using a combustion air temperature probe with connecting cable. Self-heating of the instrument during mains operation may influence the combustion air temperature measurement with a mini ambient air probe.

5.2.2. Connecting probes / sensors

- i** Probe/sensor detection at the flue gas socket is carried out continuously. New probes are recognised automatically. Connect a probe to the probe socket before switching on the measuring instrument or start sensor detection manually after changing the probe: **[Options]** → **Sensor detection**.
-

Connecting flue gas probes / gas pressure adapters / temperature adapters



- > Insert the connector plug into the flue gas socket and lock by slightly turning it clockwise (bayonet lock).
-

- i** There must be no more than one extension lead (0554 1202) between measuring instrument and flue gas probe.
-

Connecting other sensors





- > Insert the connector plug of the probe into the probe socket.

5.2.3. Switching on

- > press .
- The start screen is displayed (duration: about 5 s).
- If the voltage supply was interrupted for a longer period: The menu Date / Time is opened.
- The pressure sensors are set to zero.
- There is a device error: The **Error Diagnosis** is displayed.
- The menu **Measurements** is displayed.

5.2.4. Calling up a function









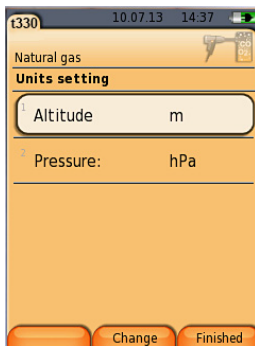

1. Select function: , .
- The chosen function appears in a frame.
2. Confirm selection: .
- The chosen function is opened.

5.2.5. Entering values

Some functions require values (numbers, units, characters) to be entered. Depending on the function that is chosen, the values are entered via either a list field or an input editor.

List field



1. Select the value to be changed (numerical value, unit): , , ,  (depending on the selected function).
2. Press .
3. Set value: , , ,  (depending on the selected function).
4. Confirm the entry: .
5. Repeat steps 1 and 4 as required.
6. Save the entry: .

Input editor

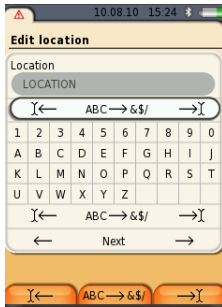

1. Select the value to be changed (character): [**▲**], [**▼**], [**◀**], [**▶**].
2. Accept value: [**OK**].
Options:
 - > Toggle between upper / lower case characters:
Select |← **ABC**→&\$/ →| : [**▲**], [**▼**] → [**ABC**→&\$/].
 - > Position the cursor in the text:
Select |← **ABC**→&\$/ →| : [**▲**], [**▼**] → [|←] or
[→|].
 - > Delete character before or after the cursor:
Select ← **next** → : [**▲**], [**▼**] → [←] or [→].
3. Repeat steps 1 and 2 as required.
4. Save the entry: Select ← **next** → : [**▲**], [**▼**] → [**Next**].

5.2.6. Show graphic

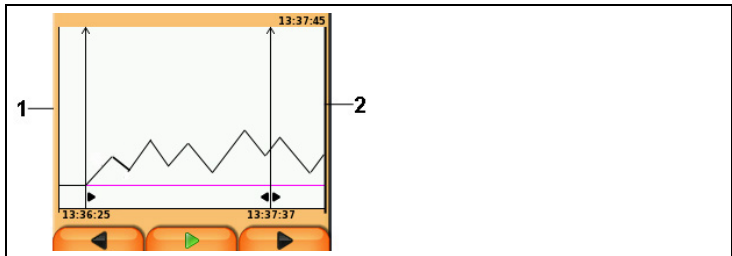

- 1 Current measuring value
 - 2 End time of the displayed period.
- The time is not displayed if no measuring value was recorded for this period.

5.2.7. Printing / saving data

Data are printed out via the function key  or the menu **Options**. Data are saved via the menu **Options**. The menu **Options** is accessed via the left function key and is available in many different menus.

Assignment of the right function key with the function **Save** or **Print**, see Assigning the right function key page 38 .

Only measuring values, which have a display field in the measurement view assigned, will be saved / printed out.

i The measurement data can be printed out parallel to the saving process, while a measurement program is running.

To be able to transmit data via infrared or Bluetooth interface to a report printer, the printer to be used must have been activated, see Activating the printer:, page 42.

i Graph charts can be printed out using the Bluetooth® / IRDA printer 0554 0620.

5.2.8. Remembering data (clipboard)

With the help of the clipboard measuring results from various measurement types can be combined to a common record, which can then be printed out (see above). Data are saved to the clipboard via the menu **Options** and the command **Clipboard**.

If there are data in the clipboard, the status bar shows the symbol .

If there are data in the clipboard and the command **Print** is triggered, all data in the clipboard will be printed out.

Only one set of measuring data can be recorded per measurement type (e.g. **Flue Gas** or **Draught**). Repetitive saving of test data of one measurement type overwrites the previously saved data. When changing the measurement place or the fuel, the clipboard is deleted.

i > **[Options]** → **Delete clipboard**: Any data saved to the clipboard is deleted.

5.2.9. Confirming an error message

If an error occurs, an error message is shown in the display.

> Confirming an error message: **[OK]**.

Errors which have occurred and have not yet been rectified are indicated by a warning symbol () in the header.

Not yet rectified error messages can be displayed in the menu **Error Diagnosis**, see **Instrument diagnosis**, page 37.

5.2.10. Switching off

i Unsaved measuring values will be lost when the flue gas analyser is switched off.

- > Press .
- Possibly: The pump starts and the sensors are rinsed until the switch-off thresholds (O₂ > 20 %, other measurement parameters < 50 ppm) are reached. The maximum rinsing period is 3 minutes.
- The measuring instrument switches off.

5.3. Address/Location

All measuring values can be saved under the currently active location. Measuring values that have not been saved are lost when the measuring instrument is switched off!

Addresses and locations can be created, edited, copied and enabled. Addresses and locations (incl. protocols) can be deleted.

Call up function:

- >  → **Address/Location** → **[OK]**.

There are various options for opening address.

1. Edit search setting: **[Edit]**.
2. Select search setting: **[▲]**, **[▼]** → **[OK]**.

Possible settings:

- **Show all**: All address/location are displayed.
- **Search**: A search text only brings up address/location that contain characteristics of the search text.
- **Filter**: Individual letters or numbers can be selected. All data beginning with the relevant letter/number is displayed.

i The initial letter is the determining factor for the **filter** function, and this can only be selected individually. The **search** function can also be used to find a series of several letters within the address!

3. Carry out search according to search setting: **[Search]**

Show all

1. Select address: **[▲]**, **[▼]**.
 2. Show details: **[Details]**.
 3. Enable a location: select the location → **[OK]**.
 - The location is activated.
- > Open measurements menu: press **[OK]** again.

Search

1. Edit search criteria: [▶] → [Edit].
2. Select search criteria: [▲], [▼] → [OK].
Possible options:
 - **Contact person**
 - **Address**
 - **Town/city**
 - **Postcode**
 - **Street**
- The selected criterion is displayed.
3. Call up entry field for search text: [▶] or [▼]
- > Enter search text → [Finished]



Do not use the special character * as a placeholder.

Filter

1. Edit search criteria: [Edit].
2. Select search criteria: [▲], [▼] → [OK].
Possible options:
 - **Contact person**
 - **Address**
 - **Town/city**
 - **Postcode**
 - **Street**
- The selected criterion is displayed.
3. Enable tab: [▼]
4. Select the required tab: [▲], [▼] and sometimes [◀], [▶] → [Filter].
- The search result for the relevant letter or number is displayed.

Create a new measuring location:

A location is always created under an address.

1. Select the address in which the location is to be created.
2. [Options] → **New/Location** → [OK].
3. Enter values or make settings.
4. Finalise the entry: [Finished].

Other location options:

- > **[Options]** → **Edit location**: make changes to an existing location.
- > **[Options]** → **Copy location**: make a copy of an existing location in the same address.
- > **[Options]** → **Delete location**: delete an existing location.

Create new address:

1. **[Options]** → **New address** → **[OK]**.
2. Enter values or make settings.
3. Finalise the entry: **[Finished]**.

Other address options:

- **Edit address**: make changes to an existing folder.
- **Copy address**: make a copy of an existing folder.
- **Delete address**: delete an existing folder, including the locations created therein.
- **Delete All addresses**: delete all existing folders, including the locations created in them.

5.4. Measurement records

Calling up the function:

- >  → **Measurement Records** → **[OK]**.

There are various options for opening protocols, **see Address/Location, page 34**

Displaying a record:

1. Choose the required record from the detailed view.
2. Print **[Data]**.

Printing all records for a location:

1. Select measuring location: **[▲]**, **[▼]**
2. Start printout: .
- All records for the location are printed out.

Options:

- > **[Options]** → **Show Graphic**: Display saved record data as graphic.
- > **[Options]** → **Print Data**: Transmit data of the chosen record to a record printer.
- > **[Options]** → **Delete Record**: Delete the chosen record.

- > **[Options]** → **Number of Lines**: Change the number of measuring values per display page.
- > **[Options]** → **Delete all Records**: Delete all saved records for a location.

5.5. Instrument diagnosis

Important operating values and instrument data are displayed. A gas path check (testo 330-2 LL) can be carried out. The status of the sensors and any device errors not yet rectified can be displayed.

Calling up the function:

- >  → **Instrument Diagnosis** → **[OK]**.
- or
- > **[i]**.

Carrying out a gas path check (testo 330-2 LL)

1. **Gas Path Check** → **[OK]**
2. Place the black sealing cap on the tip of the flue gas probe.
 - The pump flow is displayed. If the volumetric flow rate is less than 0.02 l/min, the gas paths are not leaking.
3. End of check: **[OK]**.

Viewing device errors:

- > **Error Diagnosis** → **[OK]**.
- Unrectified errors are displayed.
 - > View next / previous error: **[▲]**, **[▼]**.

View sensor diagnosis:

1. **>Sensor Diagnosis** → **[OK]**.
2. Select sensor. **[▲]**, **[▼]**.
 - The status of the sensor is indicated by a lamp.



A sensor is able to recover. It is therefore possible that the sensor status indication changes from yellow to green or from red to yellow.

View instrument information:

- > **Device Information** → **[OK]**.
- Information is displayed.

6 Using the product

6.1. Performing settings

6.1.1. Assigning the right function key

The right function key can have a function from the **Options** menu assigned to it. The menu **Options** is accessed via the left function key and is available in many different menus. This assignment is only valid for the currently opened menu / the opened function.

- ✓ A menu / function is opened in which the **Options** menu is displayed on the left function key.

1. Press **[Options]**.
2. Select option: **[▲]**, **[▼]**.

Depending on the menu / function from which the **Options** menu was opened, the following functions are available.

3. Assign the selected function to the right function key: Press **[Config. Key]**.

6.1.2. Instrument settings



It is assumed that the contents of the chapter **First steps** (see **First steps**, page 28) are known.

Calling up a function:

- > **[Menu]** → **Device Settings**.

6.1.2.1. Readings display

The parameters / units and the display representation (number of readings displayed per display page) can be set.

The settings are only valid for the currently chosen measurement type, which is indicated by the symbol in the info field.

Total overview of selectable parameters and units (available selection depends on the chosen measurement type):

Display	Parameter
FT	Flue gas temperature
AT	Combustion air temperature
ltemp	Instrument temperature
Pump	Pumping capacity
O2	Oxygen

Display	Parameter
CO ₂	Carbon dioxide
CO	Carbon monoxide
uCO	Carbon monoxide undiluted
NO	Nitrogen monoxide
NO _x	Nitrogen oxide
λ	Air ratio
amCO	Ambient carbon monoxide
amCO ₂	Ambient carbon dioxide
O ₂ ref	Oxygen reference
Edrft	external draught (micro pressure probe)
E-ΔP	external differential pressure (micro pressure probe)
qAnet	Flue gas loss without consideration of the heat value range
qAgr.	Flue gas loss under due consideration of the heat value range
η+	Efficiency under due consideration of the heat value range
η	Efficiency without consideration of the heat value range
Dew/a	Flue gas dew point temperature

Calling up the function:

>  → **Instrument Settings** → [OK] → **Readings Display** → [OK]

Changing parameter / unit in a line:

1. Select the line where you want to position the selected measurement parameter: [▲], [▼] → [Edit]
 2. Select the parameter: [▲], [▼] → [OK]
 3. Select the unit: [▲], [▼] → [OK]
 4. Save changes: [OK]
- The measurement parameter is now in the selected position on the reading display.

Options:

- > **[Options]** → **Number of Lines**: Change the number of measuring values per display page.
- > **[Options]** → **Insert Empty Lines**: Insert the empty line before the selected line.
- > **[Options]** → **Delete Line**: Delete the selected line.
- > **[Options]** → **Factory Setting**: Reset the readings display to factory setting

6.1.2.2. Alarm limits

Alarm limits can be set for several display parameters. An audible alarm signal is triggered when the alarm limit is reached.

Calling up the function:

- > **[Menu]** → **Instrument Settings** → **[OK]** → **Alarm Limits** → **[OK]**

Switching alarm signals on / off, changing alarm limits:

1. Select function or parameter: **[▲]**, **[▼]** → **[Edit]**.
 2. Set parameter: **[▲]**, **[▼]** and partly **[◀]**, **[▶]** → **[OK]**.
 3. Save changes: **[Finished]**.
- > Reset the enabled value to the factory setting: **[Standard]**.

6.1.2.3. Units

The units used for parameters in configuration menus can be set.

Calling up the function:

- > **[Menu]** → **Instrument Settings** → **[OK]** → **Units** → **[OK]**

Adjustable units

Parameter	Unit
Altitude	m, ft
Pressure	mbar, hPa

1. Select the line: **[▲]**, **[▼]** → **[Edit]**.
2. Select the unit to be changed: **[▲]**, **[▼]** → **[OK]**.
3. Confirm the entry: **[Finished]**.







6.1.2.4. Date / time

Date, time mode and time can be set.

Calling up the function:

- > **[Menu]** → **Instrument Settings** → **[OK]** → **Date/Time** → **[OK]**

Setting date/time:

1. Select parameter: [, , ] → [Edit].
2. Set parameter: [, ] and partly [, ] → [OK].
3. Save changes: [Save].







6.1.2.5. Energy management

Automatic instrument shutdown (Auto-Off) and switching off of the display light in battery operation can be set.

Calling up the function:

- > [] → Instrument Settings → [OK] → Energy Management → [OK]

Making settings:

1. Select function or parameter: [, ] → [Edit].
2. Set parameter: [, ] and partly [, ] → [OK].
3. Save changes: [Finished].

6.1.2.6. Display brightness

The intensity of the display illumination can be set.

Calling up the function:

- > [] → Instrument Settings → [OK] → Display Brightness → [OK]

Performing settings

- > Set parameter: [, ] → [OK].





6.1.2.1. Choose measurement type

Individual measurement types can be shown or hidden. These are displayed or hidden accordingly under **Measurement options**.

Call up function:

- > [] → Device settings → [OK] → Choose measurement type → [OK].

Show or hide measurement types:

1. Select measurement type: [, ]
2. Enable / disable measurement type: [] (enabled), [] (disabled)
3. Save selection: [Finished].

6.1.2.2. Printer

The headers (lines 1-3) and the footers for the printout can be set. The printer that is used can be activated.

Calling up the function:

>  → **Instrument Settings** → [OK] → **Printer** → [OK]

Activating the printer:

i The printer 0554 0543 can only be selected after the Bluetooth®-interface has been activated, see Bluetooth®, page 42.

1. **Select Printer** → [OK].
2. Select the printer: [**▲**], [**▼**] → [OK].
 - The printer is activated and the menu **Printer** is opened.

Configuring the print text:

1. **Print text** → [OK].
2. Select function: [**▲**], [**▼**] → [Edit].
 - > Enter values for **Line 1**, **Line 2**, **Line 3** and the **Footnote**
 - > Print out system data and/or customer data: 
3. Save the entry: select [**Finished**].

6.1.2.3. Bluetooth®

This menu is only available if the instrument is equipped with Bluetooth. The Bluetooth module can be switched on / off. The relay can now be tested.

Calling up the function:

>  → **Instrument Settings** → [OK] → **Bluetooth** → [Edit].

Making settings:

> Set parameter → [OK].

6.1.2.4. Language

The menu language can be set. The number of available languages depends on the activated country version, see Country version, page 43.

Calling up the function:

>  → **Instrument Settings** → [OK] → **Language** → [OK]

Activating the language:

> Select the language → [OK].

see Country version, page 43

6.1.2.5. Country version

Changing the country version may alter the basis for calculation and therefore also the displayed measurement parameters, fuels, fuel parameters and calculation formulas.

The selection of the country version influences the menu languages that can be enabled.

For information concerning the assignment table, the basis for calculation and the country version, see www.testo.com/download-center.

Calling up the function:

>  → **Instrument Settings** → [OK] → **Country Version** → [OK]



This action can be password protected. A password is specified in the menu **Password Protection**, see Password protection, page 43.



Possibly:

> Enter the password: [Enter] → Enter password → [Next] → [OK].

Setting the country version:

1. Select the country version: [▲], [▼] → [OK].
2. Confirm the confirmation request: **Yes** → [OK]
- The system is restarted.

6.1.2.6. Password protection

The password protection is only valid for functions identified by the following symbol:  or .

Password protection can be activated / deactivated, the password can be changed.

To deactivate the password protection change the password to **0000** (factory setting).

Calling up the function:

>  → **Instrument Settings** → [OK] → **Password Protection** → [OK]

Possibly:

> Enter the currently valid password:
[Enter] → Enter password → [Next] → [OK].

Changing the password:

1. **[Edit]**.
2. Enter the new password → **[Next]**.
3. **[Edit]**.
4. Enter the new password again to confirm → **[Next]**.
5. Save changes: **[Finished]**.

6.1.3. Sensor settings

6.1.3.1. NO₂ addition

The NO₂ addition parameter can be set.

The setting of the NO₂-addition can be password protected, see Password protection, page 43.

Calling up the function:

> **[]** → **Sensor Settings** → **NO₂ Addition** → **[Edit]**.

Possibly:

> Enter the password: **[Enter]** → Enter password → **[Next]** → **[OK]**.

Setting the NO₂ addition:

> Set parameter → **[OK]**.

6.1.3.2. O₂ reference

The O₂ reference value can be set.

The setting of the O₂ reference value can be password protected, see Password protection, page 43.

Calling up the function:

> **[]** → **Sensor Settings** → **O₂ Reference** → **[Edit]**.

Possibly:

> Enter the password: **[Enter]** → Enter password → **[Next]** → **[OK]**.

Setting the O₂ reference:

> Set parameter → **[OK]**.

6.1.3.3. Sensor protection

Protection limits can be set to protect the sensors against overload. Sensor protection switch-off is available for the following sensors: CO, NO.

The sensor protection is activated when the threshold is exceeded.

- testo 330-1 LL: Switch-off.
- testo 330-2 LL: Dilution, if exceeded again: Switch-off.

To deactivate sensor protection the thresholds must be set to 0 ppm.

Calling up the function:

>  → **Sensor Settings** → **Sensor Protection** → **[OK]**.

Setting sensor protection thresholds:

1. Select parameter: **[Edit]**.
2. Set parameter → **[OK]**.
3. Save changes: **[Finished]**.

6.1.3.4. Recalibration / adjustment

CO and NO sensors can be recalibrated and adjusted.

For recalibration / adjustment Testo recommends the use of the calibration adapter 0554 1205.

i If obviously unrealistic readings are displayed, the sensors should be checked (calibrated) and, if required, adjusted. Have the recalibration / adjustment carried out by a qualified service centre approved by Testo. Adjustments made with low gas concentrations can lead to accuracy deviations in the upper measuring ranges.

Calling up the function:

>  → **Sensor Settings** → **Recalibration** → **[OK]**.

Possibly:

- > Enter the password: **[Enter]** → Enter password → **[Next]** → **[OK]**.
- Gas zeroing (30 s).

Performing recalibration / adjustment:

WARNING

Dangerous gases

Danger of poisoning!

- > Observe safety regulations / accident prevention regulations when handling test gas.
- > Use test gases in well ventilated rooms only.

1. Connect the calibration adapter to the flue gas socket.
2. Select the parameter: [**▲**], [**▼**] → [**OK**].
3. [**Edit**] → Enter the test gas concentration (nominal value).
4. Attach the connecting line of the test gas bottle to the calibration adapter.
5. Apply test gas to the sensor.
6. Start recalibration: [**Start**].
7. Accept the nominal value once the actual value is stable (adjustment): [**OK**].
-or-
Abort (no adjustment): [**esc**].
8. Save changes: [**Finished**].

6.1.4. Fuels

The fuel can be selected. The fuel-specific coefficients and limits can be set.

Apart from the pre-configured fuels, 10 more customer specific fuels can be configured. Fuel parameter, see www.testo.com/download-center (registration required).



In order to maintain the measuring accuracy of the instrument one must choose or configure the correct fuel.



Correct representation of measuring results is only assured if the threshold values for the ideal range of the corresponding measurement task have been set correctly.

The pre-set threshold values are typical values for the selected system type and the chosen type of fuel.

Calling up the function:

- > [**📄**] → **Fuels** → [**OK**].

Activating fuels:

- > Select the fuel → **[OK]**.
- The fuel is activated and the main menu is opened.

Setting coefficients:

1. Select the fuel → **[Coeff.]**.
2. Select the coefficients: **[Edit]**.

Possibly:

- > Enter the password: **[Enter]** → Enter password → **[Next]** → **[OK]**.
- 3. Set values → **[OK]**.
- 4. Save changes: **[Finished]**.

Setting limits:

1. Select limit → **[Edit]**.
2. Set values → **[OK]**.
3. Save changes: **[Finished]**.

6.1.5. Programs

Five measuring programs for different measurement types can be configured and activated. The measuring programs serve the purpose of saving and representing measuring sequences. After the end of the measuring process the readings of a measuring program are automatically saved in a record.

Only one measuring program can be activated in the instrument.

Calling up the function:

- > **[]** → **Programs** → **[OK]**.

Activating / deactivating a program:

- > Select the program: **[▲]**, **[▼]** → **[Enable]** or **[Disable]**.
- When activating a program: The program is activated and the measurement type matching the program is opened.

Configuring the program:

The measuring cycle takes 1s and cannot be changed.
An activated program cannot be configured.

1. Select the program: **[▲]**, **[▼]** → **[Edit]**.
2. Select parameters program name, measurement type, gas phase: **[▲]**, **[▼]** → **[Edit]**.
3. Set parameters or enter values: **[▲]**, **[▼]** and partly **[◀]**, **[▶]** → **[OK]**.

4. Save changes: **[Finished]**.

6.2. Measuring

6.2.1. Preparing for measurement



It is assumed that the contents of the chapter **First steps** (see First steps, page 28) are known.

6.2.1.1. Zeroing phases

Measuring the ambient air temperature (AT)

If no combustion air temperature probe is connected, the temperature measured by the thermocouple of the flue gas probe during the zeroing phase is used as the combustion air temperature. All dependent parameters are calculated using this value. This method of measuring combustion air temperature is sufficient for systems dependent on ambient air. However, ensure that the flue gas probe is near the intake duct of the burner during the zeroing phase.

If a combustion air temperature probe is connected, the combustion air temperature is measured continuously via this probe.

Gas zeroing

When the instrument is switched on the measurement menu is opened and the gas sensors are zeroed.



testo 330-1 LL: The flue gas probe must be in the open air during the zeroing phase!

testo 330-2 LL: The flue gas probe can be in the flue gas duct even during the zeroing phase, if a separate VT-sensor is plugged in.

Draught / pressure zeroing

The pressure sensors are zeroed when a pressure measuring function is called up.



testo 330-1 LL: The flue gas probe must be in the open air during the zeroing phase / the instrument must not be pressurised during zeroing!

testo 330-2 LL: The flue gas probe can be in the flue gas duct even during the zeroing phase, if a separate VT-sensor is plugged in. The pressure socket of the instrument must be free (i.e. unpressurized, not closed).

6.2.1.2. Using the modular flue gas probe

Checking the thermocouple

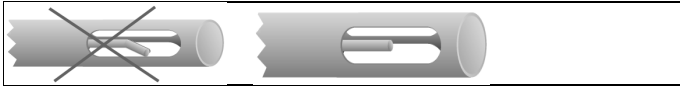

The thermocouple of the flue gas probe must not lie against the probe cage.

- > Check before use. Bend the thermocouple back if necessary.

Aligning the flue gas probe

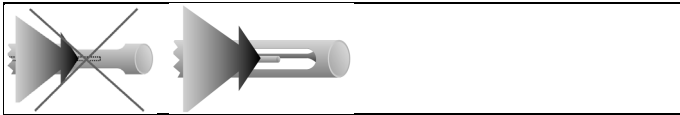

The flue gas must be able to flow freely past the thermocouple.

- > Align the probe by turning it as required.

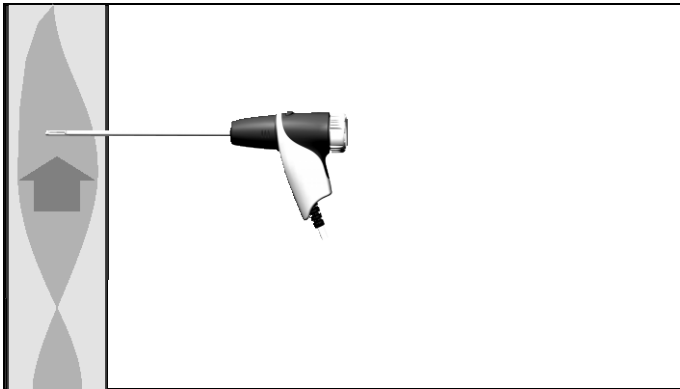

The tip of the probe must be in the hot spot of the flue gas flow.

- > Align the flue gas probe in the flue gas duct so that the tip is in the hotspot (area of the highest flue gas temperature). As a visual aid, the display shows the current temperature with a green bar. The red marking indicates the maximum measured temperature during the hotspot search. If the 🔴 symbol appears, the temperature is outside the measuring range of the flue gas probe.



The measuring value of the red marking and the 🔴 symbol can only be cancelled by restarting the flue gas menu.

6.2.1.3. Configuring the reading display

Only those parameters and units, which are activated in the reading display, appear in the reading display, the saved measurement protocols and the record printouts.

- > Before performing measurements set up the reading display in such a way, that the required parameters and units are activated, see **Fehler! Verweisquelle konnte nicht gefunden werden.**, page **Fehler! Textmarke nicht definiert.**

6.2.1.4. Setting location and fuel

Before carrying out measurements, the measurement location and the fuel must be correctly selected, see Address/Location, page 34 and Fuels, page 46.

6.2.2. Flue gas



To achieve usable measurement results, the measurement period of a flue gas measurement should be approx. 3 min and the measuring instrument should display stable measured values.

Calling up the function:

1.  → **Measurements** → **[OK]** → **Flue Gas** → **[OK]**.
2. Select the fuel → **[OK]**.

Performing the measurement:

1. Start measurement: .



If a separate measurement of CO undiluted has not yet been carried out, this value is calculated using the readings of the flue gas probe and is updated continuously.

If CO undiluted has already been measured separately, the value obtained is adopted.

- The readings are displayed.

- > **[Options]** → **Draught measure start/stop**
-



The draught measurement option is only available if the measurement parameter **Draught** is enabled in the reading display.

- Draught measurement zeroing
- Draught measurement begins automatically
- > Hold the draught measurement value displayed: **[Drgt stop]**
- The measurement stops automatically.

- The readings are automatically displayed and saved in a record.
Option
Restart the draught measurement: **[Drgt start]**
- 2. Quit measurement: **[■]**.

Options

- > **[Options]** → **Clipboard**: Data are saved to the clipboard
- > **[Options]** → **Delete clipboard**: Any data saved to the clipboard is deleted.
- > **[Options]** → **Save**: The readings are saved in a record.
- > **[Options]** → **Show Graphic**: The readings are displayed in form of a line graph.
- > **[Options]** → **Configure Graphic**: The measurement parameters to be represented (max. 4) can be displayed (⊕) or hidden (⊗).
- > **[Options]** → **Draught measure start/stop**: The measurement view is opened and a draught measurement can be carried out.
- > **[Options]** → **Flue Gas Matrix**: The readings are displayed as flue gas matrix, see below.
- > **[Options]** → **Number of Lines**: Change the number of measuring values per display page.
- > **[Options]** → **Accept measuring values from 315-3**: Ambient CO/CO₂ values measured with the testo 315-3 can be accepted by the testo 330. Data is transferred via Bluetooth® or via the IrDA interface.

i For data transfer via Bluetooth®, the testo 315 - 3 and the testo 330 - 2 must have this option, otherwise data is transferred via the IrDA interface.

- ✓ A measurement was carried out with the testo 315-3.
- ✓ testo 330-2 is on.
- ✓ Data transfer at the testo 315-3 has been enabled.
- The testo 330 accepts the instrument-specific information and measurement data sent from the testo 315-3. The measurement data is displayed under **ppm AmbCO** or **ppm AmbCO₂**.
- > **[Options]** → **Recalibrate**: The gas sensors are set to zero.
- > **[Options]** → **Measurement view**: (This function is not available during a measurement): The readings display menu is opened.

Show flue gas matrix

This function is only available if the measurement parameter **CO** has been activated in the readings display.

Calling up the function:

- ✓ The flue gas function is opened.
- > **[Options]** → **Flue Gas Matrix**:

Options

- > **[Options]** → **Clipboard**: Data are saved to the clipboard:
- > **[Options]** → **Delete clipboard**: Any data saved to the clipboard is deleted.
- > **[Options]** → **Save**: The readings are saved in a record.
- > **[Options]** → **Show Graphic**: The readings are displayed in form of a line graph.
- > **[Options]** → **Show Numerical Values**: Data are displayed as numerical values.
- > **[Options]** → **System Type**: (This function is not available during a measurement). Set the system type to be able to configure the ideal zone (green) of the flue gas matrix, using the limits pre-configured for each system type.
- > **[Options]** → **Reset Graphic**: The displayed graphical values are deleted.
- > **[Options]** → **Limits**: (This function is not available during a measurement). Enter limits to be able to configure the ideal zone (green) of the flue gas matrix.
- > **[Options]** → **CO + O2** or **CO + CO2**: Choose which parameter should be assigned to the x-axis of the display matrix (O2 or CO2).
- > **[Options]** → **Measurement view**: (This function is not available during a measurement). Open the readings display menu.

6.2.3. Draught-Measurement

Calling up the function:

- ✓ A flue gas probe must be connected.



1. **[Menu]** → **Measurements** → **[OK]** → **Draught** → **[OK]**.

Performing the measurement:





The pressure socket of the instrument must be free (i.e. unpressurized, not closed).

Do not measure for longer than 5 min, as the drift of the pressure sensor means that the readings could be outside the tolerance limits.

1. Start measurement: [].
 - Draught zeroing.
2. Position the flue gas probe in the hot spot (area of the highest flue gas temperature).
The display showing the maximum measured flue gas temperature (**FT max**) helps when positioning the probe.
 - The reading is displayed.
3. Quit measurement [].

Options:

- > **[Options]** → **Clipboard**: Data are saved to the clipboard.
- > **[Options]** → **Delete clipboard**: Any data saved to the clipboard is deleted.
- > **[Options]** → **Save**: The readings are saved in a record.
- > **[Options]** → **Show Graphic**: The readings are displayed in form of a line graph.
- > **[Options]** → **Configure Graphic**: The measurement parameters to be represented (max. 4) can be displayed () or hidden ()
- > **[Options]** → **Measurement view**: (This function is not available during a measurement): The readings display menu is opened.

6.2.4. Micro pressure probe

The following measurements can be performed using the micro pressure probe (0638 0330):

- **Ext-Draught**
- **Ext-Delta-P Single meas.**
- **Ext-Delta Program**
- **Ext 4Pa-Measurement** (only available if the country version is set to **Germany, Czech Republic, Croatia, Italy**)
- **Heating Check** (only available if the country version is set to **Germany, Czech Republic, Croatia, Italy**)

See instruction manual for micro pressure probe.

6.2.5. BlmSchV (testo 330-2 LL)

A qA mean value measurement can be carried out. For this purpose the mean value is determined continuously over a period of 30s, the measuring cycle takes 1s. The mean values actually valid at the corresponding time of recording are displayed.

Calling up the function:

✓ A flue gas probe and a combustion air temperature probe must be connected.

>  → **Measurements** → **[OK]** → **BlmSchV** → **[OK]**.

> Select the fuel → **[OK]**.

Performing the measurement:

1. Start the measurement series: 



Wait for the balancing time, until O₂ shows a value below 20 %.

2. Position the flue gas probe in the centre of flow (area of the highest flue gas temperature). The graphical representation of the maximum measured flue gas temperature (red line) helps when positioning the flue gas probe.

> Option

Start draught measurement: **[Drgt start]**

3. **[Next]**.

- The qA readings (O₂, AT, VT) and the draught value are determined (30s).

> >Option

Cancel draught measurement: **[Drgt stop]**

- The measurement stops automatically.

- The readings are automatically displayed and saved in a record.



4. Quit measurement: **[Close]**.

Options:

> **[Options]** → **Clipboard**: Data are saved to the clipboard:

> **[Options]** → **Delete clipboard**: Any data saved to the clipboard is deleted.

> **[Options]** → **Show Graphic**: The readings are displayed in form of a line graph.

> **[Options]** → **Configure Graphic**: The measurement parameters to be represented (max. 4) can be displayed () or hidden ()

- > **[Options]** → **Draught measure start/stop**: The draught measurement can be started and ended during a measurement.

6.2.6. CO undiluted

Calling up the function:

- ✓ A multi-hole probe (0554 5762) must be connected.
- > **[]** → **Measurements** → **[OK]** → **CO undiluted** → **[OK]**.

Performing the measurement:

1. Start measurement: **[▶]**
 - The reading is displayed.
2. Quit measurement: **[■]**

Options:

- > **[Options]** → **Clipboard**: Data are saved to the clipboard.
- > **[Options]** → **Delete clipboard**: Any data saved to the clipboard is deleted.
- > **[Options]** → **Save**: The readings are saved in a record.
- > **[Options]** → **Show Graphic**: The readings are displayed in form of a line graph.

6.2.7. Smoke No. / HCT

Calling up the function:

- > **[]** → **Measurements** → **[OK]** → **Smoke No. / HCT** → **[OK]**.



The parameters **Smoke No.** and **Oil derivatives** are only available for oil fuels.

Determining smoke tester no. / smoke nos. / oil derivative with the smoke pump and entering manually:

1. Select parameter → **[Edit]**.
2. Enter data or values → **[Next]** or **[OK]**.

Determining smoke tester no. / smoke nos. / oil derivative with the smoke tester testo 308 and transferring wireless:

- The testo 308 must be in data transfer mode (**Data** lights up).
- > **[Options]** → **t308**.
- The values recorded by the smoke tester are transferred to the testo 330.

Entering the heat carrier temperature:

- > **Heat carrier** → **[Edit]** → Enter value → **[OK]**.

Options:

- > **[Options]** → **Clipboard**: Data are saved to the clipboard
- > **[Options]** → **Delete clipboard**: Any data saved to the clipboard is deleted.
- > **[Options]** → **Save**: The readings are saved in a record.
- > **[Options]** → **Reset values**: The entered values are deleted.

6.2.8. Differential pressure

 WARNING	
Dangerous mixture of gases	
Danger of explosions.	
>	Make sure there are no leaks between the sampling point and the measuring instrument.
>	Do not smoke or use naked flames during measurement.



Do not measure for longer than 5 min, as the drift of the pressure sensor could have the effect that the readings are outside the tolerance limits.

- ✓ The gas pressure set (0554 1203) must be connected.

Calling up the function:

- > **[Menu]** → **Measurements** → **[OK]** → **Differential Pressure** → **[OK]**.

Performing the measurement:

- ✓ At the start of the measurement, the instrument's pressure socket must be unpressurised (e.g. instrument must not be connected to the system to be tested), as the pressure sensor has to be zeroed first.
1. Start measurement: **[▶]**.
 - Pressure zeroing.
 2. Connect a silicone hose to the testo 330-2 and the system to be tested.
 - The reading is displayed.
 3. Quit measurement: **[■]**.

Options:

- > **[Options]** → **Clipboard**: Data are saved to the clipboard
- > **[Options]** → **Delete clipboard**: Any data saved to the clipboard is deleted.
- > **[Options]** → **Save**: The readings are saved in a record.
- > **[Options]** → **Show Graphic**: The readings are displayed in form of a line graph.
- > **[Options]** → **Measurement view**: (This function is not available during a measurement): The readings display menu is opened.



6.2.9. Differential temperature

- ✓ The differential temperature set (0554 1204) must be connected.

Calling up the function:

- >  → **Measurements** → **[OK]** → **Differential Temperature** → **[OK]**.

Performing the measurement:

1. Start measurement: .
- The readings and the calculated differential temperature (T1 T2) are displayed.
2. Quit measurement: .

Options:

- > **[Options]** → **Clipboard**: Data are saved to the clipboard.
- > **[Options]** → **Delete clipboard**: Any data saved to the clipboard is deleted.
- > **[Options]** → **Save**: The readings are saved in a record.
- > **[Options]** → **Show Graphic**: The readings are displayed in form of a line graph.
- > **[Options]** → **Measurement view**: (This function is not available during a measurement): The readings display menu is opened.

6.2.10. O2 air

- ✓ An O2 dual wall clearance probe (0632 1260) must be connected.

Calling up the function:

- >  → **Measurements** → **[OK]** → **O2 Air** → **[OK]**.

Performing the measurement:

1. Start measurement: .

- The reading is displayed.
2. Quit measurement: [.

Options:

- > [**Options**] → **Clipboard**: Data are saved to the clipboard.
- > [**Options**] → **Delete clipboard**: Any data saved to the clipboard is deleted.
- > [**Options**] → **Save**: The readings are saved in a record.
- > [**Options**] → **Show Graphic**: The readings are displayed in form of a line graph.



6.2.11. Gas flow

The function is only available if the chosen fuel is a gas.

Calling up the function:

- > [Measurements → [**OK**] → **Gas Flow** → [**OK**].

Performing the measurement:

1. Start measurement: [].
 - The measuring duration is displayed.
2. When the adjusted gas flow is reached: [].
 - The calculated gas flow and the gas burner capacity (in kW) are displayed.

Options:

- > [**Options**] → **Clipboard**: Data are saved to the clipboard.
- > [**Options**] → **Delete clipboard**: Any data saved to the clipboard is deleted.
- > [**Options**] → **Save**: The readings are saved in a protocol.
- > [**Options**] → **Enter heating value**: heating value can be set.
- > [**Options**] → **Units setting**: the unit for gas flow, heating value, duration and GasPgr can be changed.

6.2.12. Oil flow

The function is only available if the chosen fuel is an oil.

Calling up the function:

>  → **Measurements** → [OK] → **Oil Flow** → [OK].

Performing the measurement:

1. Select the parameters **Oil Flow** (of the oil nozzle) and **Oil Pressure** (no effect on calculation): [▲], [▼] → [Edit].
2. Enter values. [▲], [▼] and partly [◀], [▶] → [OK].
 - The calculated oil burner capacity (in kW) is displayed.

Options:

- > [Options] → **Clipboard**: Data are saved to the clipboard
- > [Options] → **Delete clipboard**: Any data saved to the clipboard is deleted.
- > [Options] → **Save**: The readings are saved in a protocol.
- > [Options] → **Unit settings**: The unit for the oil flow can be changed (**kg/h** > **gal/h** or **gal/h** > **kg/h**).

6.2.13. CO ambient

- ✓ An ambient CO probe (recommended) or a flue gas probe must be connected.



Cigarette smoke influences the measurement by more than 50 ppm. The breath of a smoker influences the measurement by about 5 ppm.

When using an ambient CO probe, note that:

The direction of flow of the gas has an effect on the accuracy of the measurement. Frontal flow onto the probe leads to higher readings. The best measurement results are achieved when the probe is moved gently backwards and forwards.



When using the ambient CO probe and the flue gas probe, note that:

The probe must be in the open air (CO-free) during the zeroing phase!

Calling up the function:

>  → **Measurements** → [OK] → **CO Ambient** → [OK].

Performing the measurement:

1. Start measurement: [].
 - The measurement starts and the measuring value is displayed graphically (trend display).
 - An audible alarm signal is triggered when the alarm limit is reached.
2. Quit measurement: [].
3. Confirm the message: [OK].

Options:

- > [Options] → **Clipboard**: Data are saved to the clipboard.
- > [Options] → **Delete clipboard**: Any data saved to the clipboard is deleted.
- > [Options] → **Save**: The readings are saved in a record.
- > [Options] → **A-Thresh.**: The alarm limits menu is opened.

6.2.14. CO2 ambient

- ✓ An ambient CO2 probe (0632 1240) must be connected.









In order to obtain correct readings, it is imperative to enter the prevailing absolute pressure. This can be entered directly (**Pressure Absolute**), or it is automatically calculated when entering **Altitude** and barometric pressure (**Pressure Barom.**).

Calling up the function:

- > [] → **Measurements** → [OK] → **CO2 Ambient** → [OK].

Performing the measurement:

1. Select parameter → [Edit].
2. Enter values. [, ] and partly [, ] → [OK].
3. Start measurement: [].
4. Quit measurement: [].
 - The ambient CO2 value is displayed.

Options:

- > [Options] → **Clipboard**: Data are saved to the clipboard.
- > [Options] → **Delete clipboard**: Any data saved to the clipboard is deleted.
- > [Options] → **Save**: The readings are saved in a record.

- > **[Options]** → **Show Graphic**: The readings are displayed in form of a line graph.
- > **[Options]** → **Alarm Limit**: The alarm limits menu is opened.
- > **[Options]** → **Edit**. Values for adjustable parameters can be edited.
- > **[Options]** → **Sensor detection**: newly inserted sensor is detected.
- > **[Options]** → **Measurement view**: (This function is not available during a measurement): The readings display menu is opened..

6.2.15. Automatic furnaces

With the help of the readout adapter for automatic furnaces (0554 1206) status data and error messages can be read out of compatible automatic furnaces, see also documentation on readout adapter. The range of data which can be read out depends on the type of the automatic furnace.















Calling up the function:

1. Connect the readout adapter to the instrument (PS2 interface (for devices until 2017)) and to the automatic furnace (use adapter ring if necessary).
2.  → **Measurements** → **[OK]** → **Automatic Furnace** → **[OK]**.
 - The data are read from the automatic furnace. Depending on the automatic furnace, the data are updated at the latest every 30 s.

i The values are saved in a measuring report or transferred to a pocket PC / PC, together with the measuring values of a flue gas measurement.

Reading out current status data:

The current data are displayed after a connection has been set up to the automatic furnace. The following data are displayed with the help of symbols:

Component	Status ON	Status OFF
Air controller		
Motor		
Valve 1		
Valve 2		
Flame		
Ignition		
Oil prewarmer		

Options

- > **[Options]** → **Clipboard**: Data are saved to the clipboard.
- > **[Options]** → **Delete clipboard**: Any data saved to the clipboard is deleted.
- > **[Options]** → **Save**: The readings are saved in a record.
- > **[Options]** → **Adapter Information**: Type and version of readout adapter are displayed.
- > **[Options]** → **Identification**: Information about manufacturer and type of automatic furnace
- > **[Options]** → **Statistics**: Display of error statistics.



Automatic furnaces are equipped with a circular buffer memory: Error messages are overwritten when the error log is full. The fault that has occurred last is at position 1 in the error list.

- > **[Options]** → **Fault**: Display of faults.

6.2.16. Solid fuel measurement

The solid fuel measurement program is only available with instruments that come with the CO sensor (not COlow). For measurements in accordance with the 1st Federal Immission Control Ordinance (BImSchV), a CO,H₂-compensated sensor (0393 0101) is required.



The function is only available if the activated fuel is solid fuel and adapter 0600 9765 has been connected.

Calling up the function:

- > **[Menu]** → **Measurement options** → **[OK]** → **Solid fuel** → **[OK]**.

Performing the measurement:

1. Select parameters gas phase, meas. rate or stability time: **[▲]**, **[▼]** → **[Change]**.
2. Enter values. **[▲]**, **[▼]** and partly **[◀]**, **[▶]** → **[OK]**.
3. **[Finished]**.
4. Insert the flue gas probe into the exhaust pipe and position it in the hot spot.

5. Start measurement: 
 - The stabilisation phase (minimum 2 min) progresses. After this the measuring phase starts automatically (minimum 5 min).





The stabilisation phase can be interrupted early.

> Press **[Next]**.

- The measuring phase starts automatically.

-
- The measuring result is displayed after the measuring phase has been completed.

Options:

- > **[Options]** → **Clipboard**: Data are saved to the clipboard.
- > **[Options]** → **Delete clipboard**: Data in the clipboard are deleted.
- > **[Options]** → **Save**: The readings are saved in a record.
- > **[Options]** → **Show Graphic**: The readings are displayed in form of a line graph.
- > **[Options]** → **Configure Graphic**: The measurement parameters to be represented (max. 4) can be displayed () or hidden () werden.
- > **[Option]** → **Measurement view**: (This function is not available during a measurement): The readings display menu is opened.

6.2.17. Gas pipe tests

Calling up the function:

- >  → **Measurements** → **[OK]** → **Gas Pipe Tests** → **[OK]**.

6.2.17.1. Tightness test 1



Leak test on gas pipes acc. to DVGW-TRGI 2008 worksheet G600

The leak test (using air or inert gas, e.g. CO₂ or N₂) is used for acceptance testing of newly routed or remedied pipes.

The test is performed at the pipe, including the fittings, without gas installations and corresponding control and safety equipment. For this test the line must be pressurised with 150 mbar, whereby this pressure must remain constant for 10 minutes.

This applies to lines < 100 l. For larger line volumes, the stability time and measurement period should be adjusted in accordance with DVGW-TRGI 2008 worksheet G600.

-
- > Connect the connecting plug of the hose pressure connection set (0554 1203) to the pressure test set (0554 1213), plug the

pressure adapter onto the flue gas socket and lock in place by slightly turning it clockwise (bayonet lock).

Performing the measurement:

- ✓ The pressure socket of the instrument must be free (i.e. unpressurized, not closed).
- 1. **Tightness Test 1** → [OK].
 - Pressure zeroing.
- 2. Select parameter: [▲], [▼] → [Edit].
- 3. Set parameters or enter values: [▲], [▼] and partly [◀], [▶] → [OK].
- 4. Pressurise the system.

i Once the pressure has built up, a stability time specified by DVGW-TRGI 2008 should be observed to ensure that any possible pressure fluctuations are not recorded in the measurement. The relevant standard provides more detailed information.

- 5. Start measurement: [▶].
 - The stability time will run. After this the measuring phase starts automatically.
 - > End stability time and measurement early: [Next].
 - The readings are displayed when measurement has been completed.

6.2.17.2. Tightness test 2

i

- Follow DVGW-TRGI 2008, worksheet G624.
- **Pressure Absolute** (parameter of location) must strictly be entered to obtain correct readings. If this is unknown it is recommended to use the value 966hPa (corresponds with 1013 hPa barometric, altitude 400 m)
To enter the values:
 - > [📄] → **Measurements** → [OK] → **Gas Pipe Tests** → [OK] → **[Tightness Test 2]** → [Fold./Meas.] → [Options] → **Edit Location**.

- > Plug the connecting plug of the hose connection set (0554 1203) into the flue gas socket and lock in place by turning it slightly clockwise (bayonet lock).

Performing the measurement:

- ✓ The pressure socket of the instrument must be free (i.e. unpressurized, not closed).

1. **Tightness Test 2** → [OK].
2. Select parameter: [▲], [▼] → [Edit].
3. Set parameters or enter values: [▲], [▼] and partly [◀], [▶] → [OK].



Three circular diameters and three pipe lengths can be entered, which are then used to calculate three partial volumes. The pipe volume is calculated by adding these three partial volumes.

4. [measurement].
 - Pressure zeroing.
5. Pressurise the system.
6. Start measurement: [▶].
 - The stability time will run. After this the measuring phase starts automatically.
 - > End stability time and measurement early: [Next].
 - The readings and **Result Tightness Test 2** are displayed when measurement has been completed.
7. [Edit] → Select test result: [▲], [▼] → [OK].

6.2.17.3. Let By Test

- > Plug the connecting plug of the hose connection set (0554 1203) into the flue gas socket and lock in place by turning it slightly clockwise (bayonet lock).

Performing the measurement:

- ✓ The pressure socket of the instrument must be free (i.e. unpressurized, not closed).
1. **Let By Test** → [OK].
 - Pressure zeroing.
 2. Select parameter: [▲], [▼] → [Edit].
 3. Set parameters or enter values: [▲], [▼] and partly [◀], [▶] → [OK].
 4. Pressurise the system.
 5. Start measurement: [▶].
 - The stability time will run. After this the measuring phase starts automatically.
 - > End stability time and measurement early: [Next].
 - The readings and **Result Let By Test** are displayed when measurement has been completed.
 6. [Edit] → Select test result: [▲], [▼] → [OK].

6.2.17.4. Leak detection

In gas leak detection no measurement is made, but a gas detection is performed.

- ✓ A gas leak probe (0632 3330) must be connected.



You must also refer to the documentation that comes with the gas leak probe.

Calling up the function:

- > **Leak Detection** → **[OK]**.

Performing the detection:

- > Set the gas type to be detected and perform gas leak testing by following the instructions described in the documentation of the gas leak probe.
1. Start detection: **[▶]**.
 - The gas concentration is displayed, if it exceeds the limit an alarm signal will sound.

Options:

- > **[Options]** → **Save**: the readings are saved in a record.
 - > **[Options]** → **Show Graphic**: The readings are displayed in form of a line graph.
 - > **[Options]** → **Alarm Limit**: (This function is not available during a measurement): Adjusting alarm limits.
 - > **[Options]** → **Alarm Signal**: (This function is not available during a measurement): Alarm signal disable/enable.
 - > **[Options]** → **Zeroing Probe**: Perform zeroing.
 - > **[Options]** → **Sensor detection**: newly inserted sensor is detected.
2. End detection: **[■]**.

6.3. Transferring data

6.3.1. Report printer

To be able to transmit data via infrared or Bluetooth interface to a Testo report printer, the printer to be used must have been activated, see Printer, page 42.

Printing out data takes place via **[Print]** or **[🖨️]**. The function is only available if a printout is possible.

i Representation of the available characters per line is limited on the printout. Thus, the unit **mg/KWh** is displayed on the printout as **mg/k**.

6.3.2. **PC / Pocket PC**

Data transfer to a PC can take place via USB, IrDA or Bluetooth®.

Data transfer to a Pocket PC can take place via IrDA or Bluetooth®.

You must also refer to the documentation that comes with the software.

7 Maintaining the product

7.1. Cleaning the measuring instrument

- > If the housing of the measuring instrument is dirty, clean it with a damp cloth.

i Use distilled water, or alternatively mild solvents such as isopropanol to clean the flue gas analyzer. If using isopropanol, please refer to the instruction leaflet for the product. Isopropanol fumes have a slight narcotic effect, and typically cause irritation of the eyes and sensitive mucous membranes. When using it, please ensure that there is adequate ventilation.

i Do not store any objects that have come into contact with solvents and/or degreasers (e.g. isopropanol) in the case. Evaporating or leaking solvents and/or degreasers may cause damage to the instrument and to the sensors.

i The use of strong or harsh alcohol or brake cleaner can result in damage to the instrument.

7.2. Replacing sensors

 **CAUTION**

**Acid in the sensors.
May cause chemical burns.**

- Do not open the sensors.
- Always wear gloves when changing a sensor.
Eye contact: Rinse the affected eye thoroughly under running water for 10 minutes, keeping the eyelids wide open and protecting the unaffected eye. Remove contact lenses wherever possible.

i A slot bridge (0192 1552) must be inserted in slots which are not equipped with a sensor. Used sensors must be disposed of as hazardous waste!

- ✓ The instrument must be switched off.
- 1. Place the measuring instrument on its front.
- 2. Remove the service cover: Take hold of it at the markings (arrows) using the index finger and thumb, press slightly, fold up and remove.
- 3. Pull hose connections from the faulty sensor / bridge.
- 4. Remove the faulty sensor / bridge from the slot.

- > For NO-sensor: Remove the auxiliary circuit board.



i Do not remove the auxiliary circuit board for the NO-sensor until immediately before installation. Do not leave the sensor without auxiliary circuit board for longer than 15 min.

5. Install new sensor / new bridge in the slot.
 6. Plug the hose connections on sensor / bridge.
 7. Attach the service cover and engage it in place.
-

i After replacing an O₂ sensor, wait for an equalisation period of 15 min to elapse before using the instrument again.

When retrofitting a sensor the associated measurement parameter and unit must be enabled.

When replacing an O₂ sensor, if the power supply is interrupted for more than 10 hours, we recommend an acclimatization time of 1 hour to maintain the measuring accuracy.

7.3. Recalibrating / adjusting sensors

See Sensor settings, page 44.

7.4. Replacing additional filter

The additional filter provides added protection should problems occur with the particle filter in the flue gas probe. The additional filter is very rarely contaminated if the measuring instrument is used normally.

- > Check the additional filter (visually) periodically for contamination and replace it if necessary.

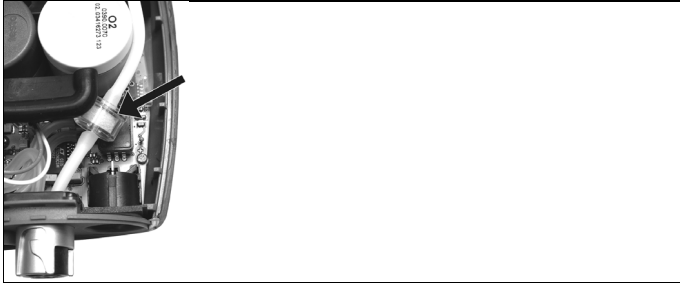

1. Place the measuring instrument on its front.
2. Remove the service cover: Take hold of it at the markings (arrows) using the index finger and thumb, press slightly, fold up and remove.
3. Loosen the additional filter from the hose connection.
- 4 Plug the new filter (0133 0010) into the hose connection.
5. Attach the service cover and engage it in place.

7.5. Cleaning the modular flue gas probe

- ✓ Disconnect the flue gas probe from the measuring instrument prior to cleaning.
1. Release the probe catch by pressing the key on the probe handle and remove the probe module.

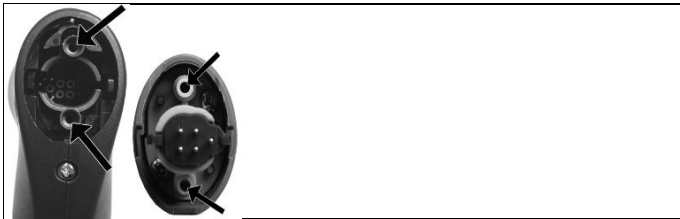

2. Blow compressed air through the flue gas ducts in probe module and probe handle (see illustration). Do not use a brush!
3. Fit a new probe module on the probe handle and engage it in place.

7.6. Replacing the probe module

- ✓ Disconnect the flue gas probe from the measuring instrument prior to cleaning.

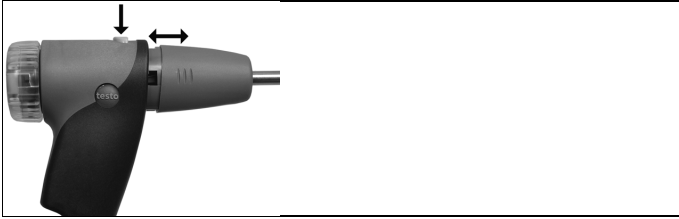

1. Press the key on the top of the probe handle and remove the probe module.
2. Plug in the new probe module and engage it in place.

7.7. Changing the thermocouple

1. Release the probe catch by pressing the key on the probe handle and remove the probe module.

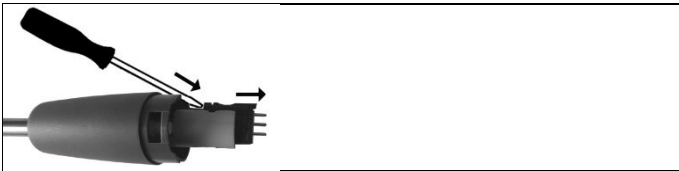

2. Remove the thermocouple plug-in head from the socket using a screwdriver and pull the thermocouple out of the probe shaft.
3. Keep inserting the new thermocouple into the probe shaft until the connection head clicks into place.
4. Fit a new probe module on the handle and engage in place.

7.8. Condensate container

The fill level of the condensate trap can be read from the markings on the condensate trap. A warning message (⚠, red flashing light) is displayed if the fill level in the condensate trap reaches 90%. The fill level of the condensate trap can be read from the markings.

Draining the condensate trap

i The condensate consists of a weak mix of acids. Avoid skin contact. Make sure that the condensate does not run over the housing.

⚠ CAUTION

Condensate entering the gas path.

Damage to sensors and flue gas pump!

- > Do not empty the condensate trap while the flue gas pump is in operation.

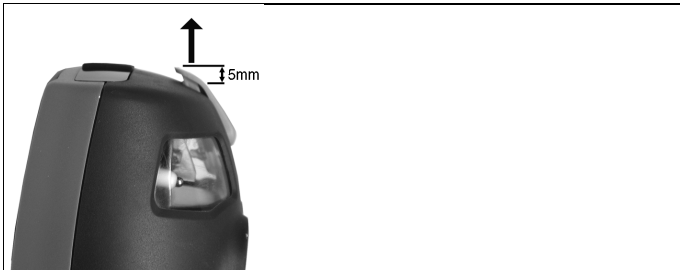

1. Unlock the condensate trap and pull it vertically off the measuring box.
2. Open the condensate outlet on the condensate trap: Pull out approx. 5 mm against the stop.



3. Let the condensate run out into a sink.
4. Wipe off any drops still on the condensate outlet with a cloth and close the condensate outlet.

i The condensate outlet must be completely closed (marking), otherwise measuring errors could be caused by infiltrated air.

7.9. Checking / replacing the particle filter

Checking the particle filter:

Check the particle filter of the modular flue gas probe periodically for contamination: check visually by looking through the window of the filter chamber.

Replace the filter if there are signs of contamination.

Replacing the particle filter:

i The filter chamber may contain condensate.



1. Open the filter chamber: Turn gently anti-clockwise.
2. Remove the filter plate and replace it with a new one (0554 3385).
3. Attach the filter chamber and lock it. Turn gently clockwise.

8 Tips and assistance

8.1. Questions and answers

Question	Possible causes / solution
Rechargeable battery low	> Switch to mains operation.
Measuring instrument switches automatically off or cannot be switch on	Batteries / rechargeable batteries empty. > Charge rechargeable batteries or switch to mains operation.
Displayed battery capacity seems to be faulty	Rechargeable battery was repeatedly not fully discharged/charged. > Discharge rechargeable battery (until measuring instrument switches off automatically) and then charge fully.
Error message: Pump flow too high	Gas outlet blocked > Make sure that the gas outlet is clear.
Error message: Sensor protection active	The shutdown limit of the CO sensor was exceeded. > Remove the probe from the stack.
Error message: Printing not possible	<ul style="list-style-type: none"> • With printer 0554 0543: Bluetooth interface not activated. • Wrong printer activated. • Printer switched off. • Printer outside wireless transmission range. > Activate Bluetooth interface, see Bluetooth®, page 42. > Activate printer used, see Printer, page 42. <ul style="list-style-type: none"> • Switch on printer. > Move printer within wireless transmission range.

If we could not answer your question, please contact your dealer or Testo Customer Service. Contact data see back of this document or website www.testo.com/service-contact.

8.2. Accessories and spare parts

Printer

Description	Article no.
Infrared high-speed printer	0554 0549
Bluetooth® /IRDA printer, incl. Mains unit 5 V / 1.0 A with micro USB cable	0554 0620
Mains unit 5 V / 1.0 A with micro USB cable	0554 1105
Spare thermal paper for printer (6 rolls)	0554 0568

Modular flue gas probes

Description	Article no.
Modular flue gas probe 180 mm, 500 °C, thermocouple 0.5 mm, probe shaft diameter: 8mm	0600 9760
Modular flue gas probe 300 mm, 500 °C, thermocouple 0.5 mm, probe shaft diameter: 8mm	0600 9761
Modular flue gas probe 180 mm, 500 °C, thermocouple 0.5 mm, probe shaft diameter: 6mm	0600 9762
Modular flue gas probe 300 mm, 500 °C, thermocouple 0.5 mm, probe shaft diameter: 6mm	0600 9763
Flexible flue gas probe, length 330 mm, Tmax. 180 °C, short-term 200 °C, bending radius max. 90° for measurements at difficult to access locations	0600 9770

Probe modules / accessories for modular flue gas probes

Description	Article no.
Probe shaft module 180 mm, 500 °C, thermocouple 0.5 mm, probe shaft diameter: 8 mm	0554 9760
Probe shaft module 300 mm, 500 °C, thermocouple 0.5 mm, probe shaft diameter: 8 mm	0554 9761
Probe shaft module 180 mm, 500 °C, thermocouple 0.5 mm, probe shaft diameter: 6 mm	0554 9762
Probe shaft module 300 mm, 500 °C, thermocouple 0.5 mm, probe shaft diameter: 6 mm	0554 9763

Description	Article no.
Probe shaft module 300 mm, 1,000 °C, thermocouple 1.0 mm, probe shaft diameter: 6 mm	0554 8764
Probe shaft module 700 mm, 1,000 °C, thermocouple 1.0 mm, probe shaft diameter: 6 mm	0554 8765
Spare thermocouple for module 0554 9760, 0554 9762	0430 9760
Spare thermocouple for module 0554 9761, 0554 9763	0430 9761
Spare thermocouple for module 0554 8764	0430 8764
Spare thermocouple for module 0554 8765	0430 8765
Cone, 8 mm, steel	0554 3330
Cone, 6 mm, steel	0554 3329
Multi-hole probe shaft, length 300 mm, Ø 8 mm, for CO averaging	0554 5762
Multi-hole probe shaft, length 180 mm, Ø 8 mm, for CO averaging	0554 5763
Flexible probe shaft module	0554 9770
Hose extension 2.8 m, extension line probe - instrument	0554 1202
Particle filter, 10 pcs.	0554 3385

Temperature sensor

Description	Article no.
Ambient air temperature (AT) probe, 300 mm	0600 9791
Ambient air temperature (AT) probe, 190 mm	0600 9787
Ambient air temperature (AT) probe, 60 mm	0600 9797
Fast reaction surface sensor	0604 0194
Miniature ambient air sensor	0600 3692

Other probes / sensors

Description	Article no.
O2 annular gap probe	0632 1260
Gas leak probe	0632 3330
Ambient CO probe	0632 3331

Description	Article no.
CO2 ambient probe (without connecting cable)	0632 1240
Connecting cable for CO2 ambient probe, 1.5 m	0430 0143
Gas pressure set: Draught path adapter, silicone hose 4 mm / 6 mm, reducing cones	0554 1203
Differential temperature set, 2 pipe wrap probes, adapter	0554 1204
Smoke tester inc. oil, soot plates, for measuring soot in flue gas	0554 0307

Retrofit sensors

Description	Article no.
NO retrofit	0554 2151

Spare sensors

Description	Article no.
O2 sensor	0393 0002
O2 sensor	0393 0051
O2 sensor H2 compensated	0393 0101
COlow sensor	0393 0103
NO sensor	0393 0151
NOlow sensor	0393 0152

Cases

Description	Article no.
System case with double floor (height: 180 mm) for instrument, probes and accessories	0516 3301
System case (height: 130 mm) for instrument, probes and accessories	0516 3300

Other accessories

Description	Article no.
Mains unit	0554 1096
Charger with spare rechargeable battery	0554 1103
Spare rechargeable battery	0515 0107
Readout adapter for automatic furnaces	0554 1206
Connecting cable instrument / PC	0449 0047
Aasyheat (PC configuration software)	0554 3332
Additional filter	0133 0010
Draught set	0554 3150
Fine pressure probe	0638 0330
Set of capillary hoses	0554 1215
Solid fuel measurement module with adapter and probe shaft with sintered filter	0600 9765
Sintered filter for solid fuel measurement probe shaft	0133 0035
Filter material for condensate trap on solid fuel measurement adapter	0554 3371
NOx-Filter	0554 4150
Pressure test set for gas line testing	0554 1213
ISO Calibration Certificate Flue Gas	0520 0003

For a complete list of all accessories and spare parts, please refer to the product catalogues and brochures or look up our website www.testo.com

8.3. Updating the instrument software

Under www.testo.com/download-center you can download the current instrument software (Firmware) for testo 330 (registration required).

- > Unplug the mains unit and switch off the testo 330.
- 1. Hold [▲] depressed.
- 2. Plug in the mains unit, keep [▲] depressed.
 - The display shows **Firmware update** along the bottom edge.
- 3. Release [▲] .
- 4. Insert the connecting cable (0449 0047) into the USB-port on the instrument, then connect it to the PC.
 - Your PC recognises the testo 330 as a removable medium.
- 5. Copy the new file (ap330rel.bin) to the detected removable medium.
 - In the display the status bar progresses from left to right. This process may take a few minutes.
- 6. Disconnect the connecting cable from the testo 330.
 - After updating of the instrument software (Firmware) has been completed the system will automatically reboot and is ready for use.



Testo SE & Co. KGaA

Celsiusstraße 2

79822 Titisee-Neustadt

Germany

Telefon: +49 7653 681-0

E-Mail: info@testo.de

Internet: www.testo.com