

NEW!!!

60 V Common Mode Differential Probes



TELEDYNE LECROY
Everywhereyoulook™

Contents

- Target Market
- Product Overview
- Target Applications
- Competitive Landscape
- Appendices

Power Conversion Market

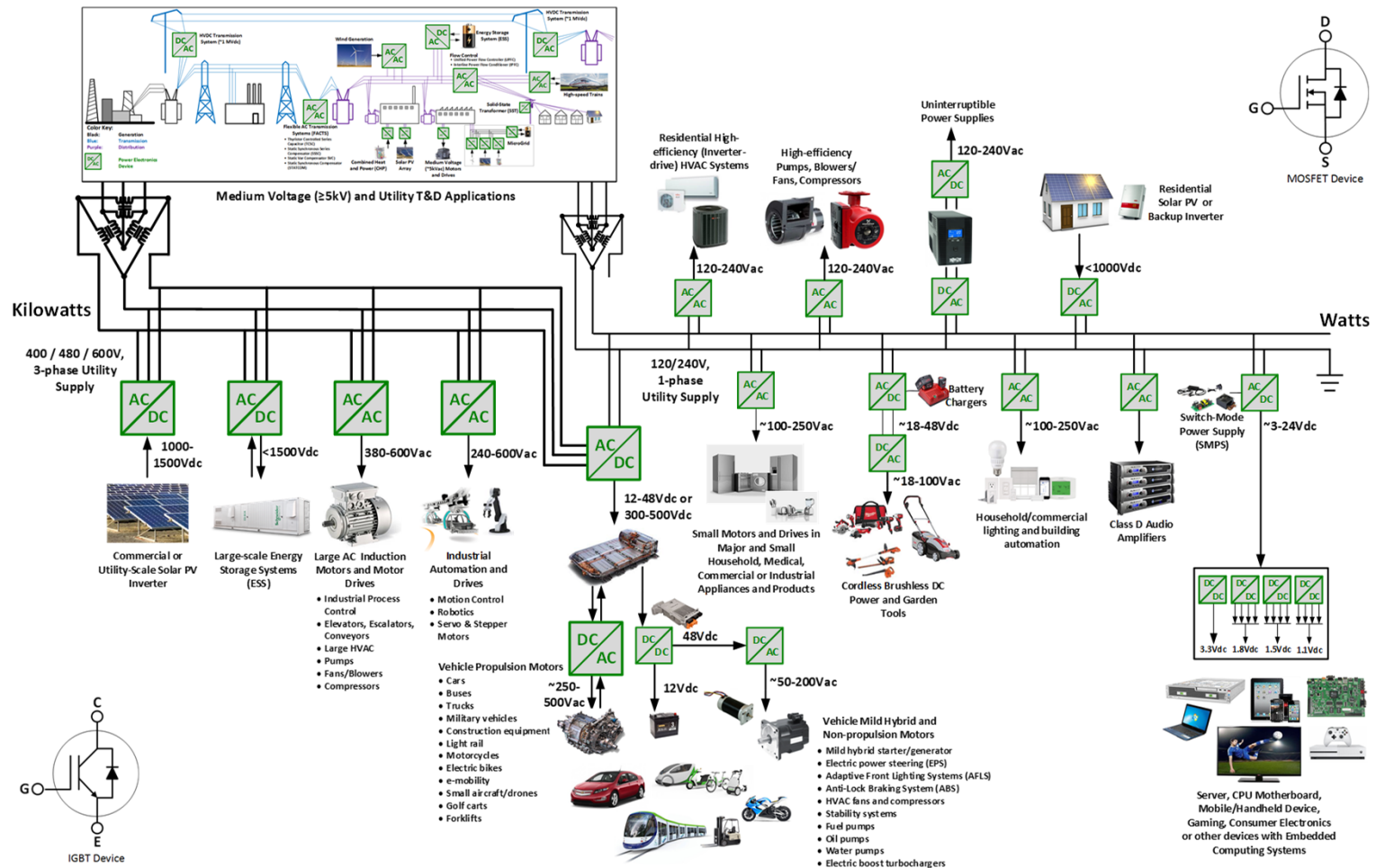

Market Applications for SiC → >500 V

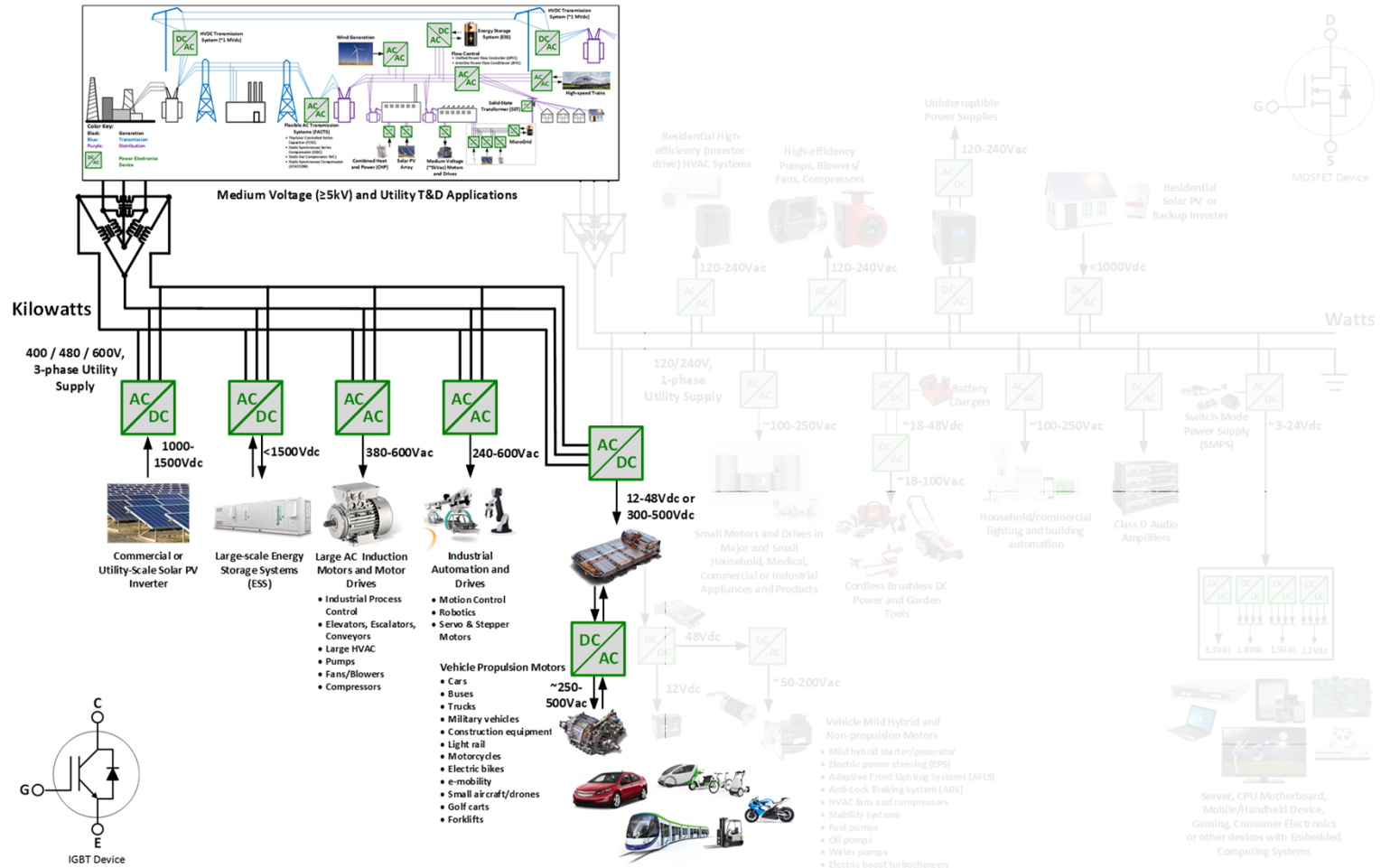

Market Applications for GaN $\rightarrow \leq 500\text{ V}$

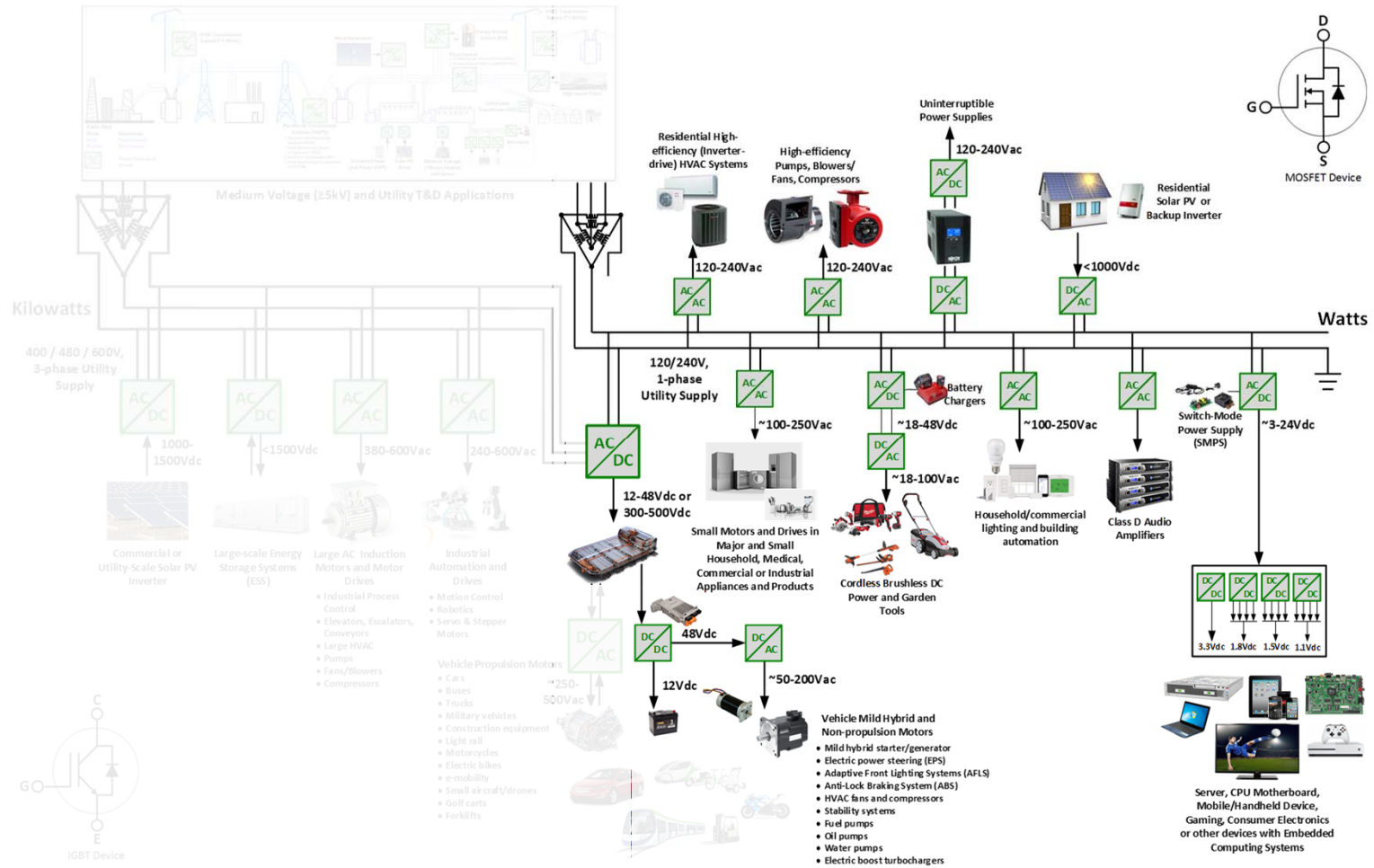

60 V Common Mode Differential Probes

Product Overview



TELEDYNE LECROY
Everywhereyoulook™

60 V Common Mode Differential Probes

Ideal probes for lower voltage GaN power conversion measurements

DL-HCM Probes

- DL= **D**ifferential **L**ow
- “-HCM” = **H**igh **C**ommon **M**ode

Two Models

- DL05-HCM (500 MHz)
- DL10-HCM (1 GHz)



DL-HCM Key Features and Banner Specs

Ideal probe for 48 V Power Conversion

- 500 MHz and 1 GHz bandwidth
- 60 V common mode range
- 80 V differential range

Highest accuracy

- 0.5% gain accuracy
- Precision gain calibration
- Best LF flatness (0.1 dB)

Lowest noise and highest rejection

	DL05-HCM	DL10-HCM
Bandwidth	500 MHz	1 GHz
Common mode range	±60 V (DC + peak AC)	
Differential range	±80 V (DC+ peak AC)	
Gain accuracy	0.5%	
LF Flatness	DC to 100MHz: 0.1 dB	
CMRR	80dB @ 10 kHz 70dB @ 100 kHz 50dB @ 100 MHz 35dB @ 500 MHz 30dB @ 1GHz	

Wide Variety of Tips

More details on the tips in [Appendix A](#)

Standard

- High performance solder-in (qty 2.)
- 2" solder-in tip
- Browser
- 2" y-lead
- 5" y-lead
- Single pin header (Qty. 2)
- Single pin (Qty. 6)
- Mini grabbers (Qty. 3)
- Ground lead
- New, clear case

Optional

- High temp solder-in (DL-HCM-HiTemp)
- Y-banana adaptor (DL-HCM-ACC-KIT)
- Micro grabber (DL-HCM-ACC-KIT)
- Probe Holder (DL-HCM-ACC-KIT)

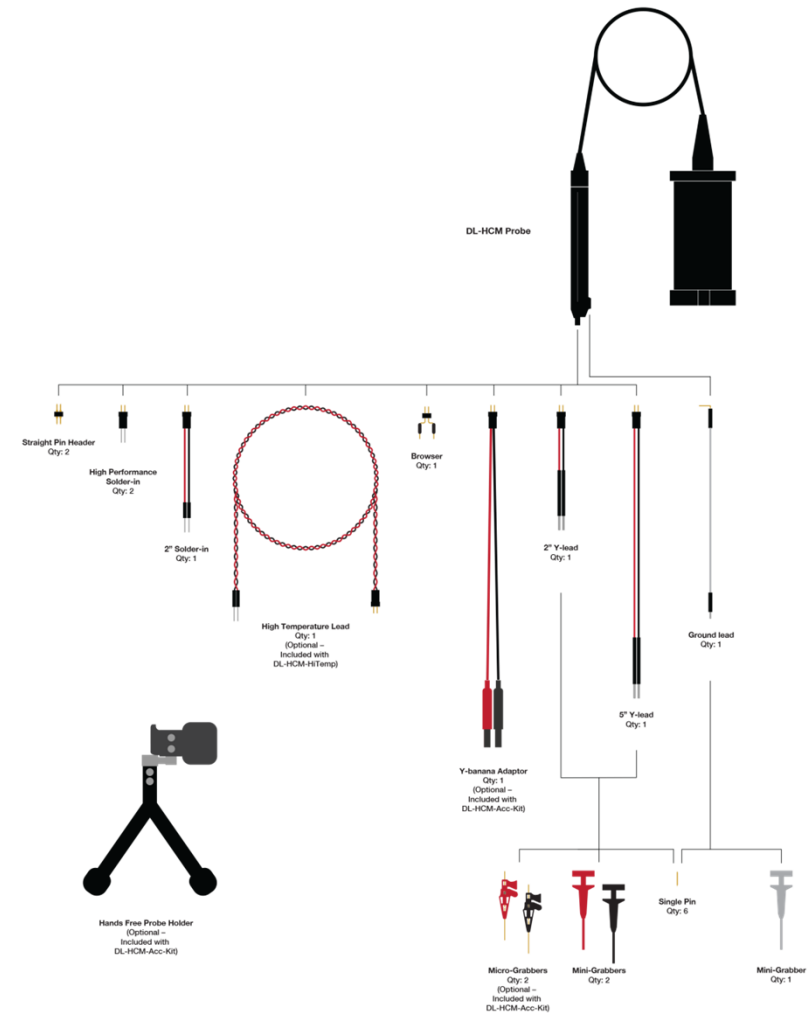

Pricing and Compatibility

Part Number	Description
DL05-HCM	500 MHz 60V Common Mode Differential Probe. Includes standard set of leads and tips.
DL10-HCM	1 GHz 60V Common Mode Differential Probe. Includes standard set of leads and tips.
DL-HCM-Acc-Kit	DL-HCM series accessories kit with probe holder, micro IC grabbers (Qty 2.), and Y-banana adaptor.
DL-HCM-HiTemp	DL-HCM series high-temperature solder-in tip, 30 MHz bandwidth, 1 meter length.

- Requires firmware 9.3.0.7
 - web Released on Oct 2020

What about the Higher Voltage GaN (500 V switching)?

- There is an active R&D project to address this
- It requires several key technologies that are new to our design team
- Expected to be brought to market later in 2021
- Expectations: it will be very competitive against IsoVu

60 V Common Mode Differential Probes

Target Applications



TELEDYNE LECROY
Everywhereyoulook™

Ideal probe for 48 V Power Conversion

Target Applications:

- 48 V motors and drives
- High-power DC-DC converters

Other possible target applications:

- GaN-based PDNs
- AC-DC switch-mode power supplies
- Wireless charging systems
- Gate-drive measurements
- Shunt resistor measurements

Target Application #1: 48 V Motors and Drives

Companies who make 12-48 V drive systems

ie: Robert Bosch, Aptiv/Delphi, Continental, Milwaukee Tools, etc.

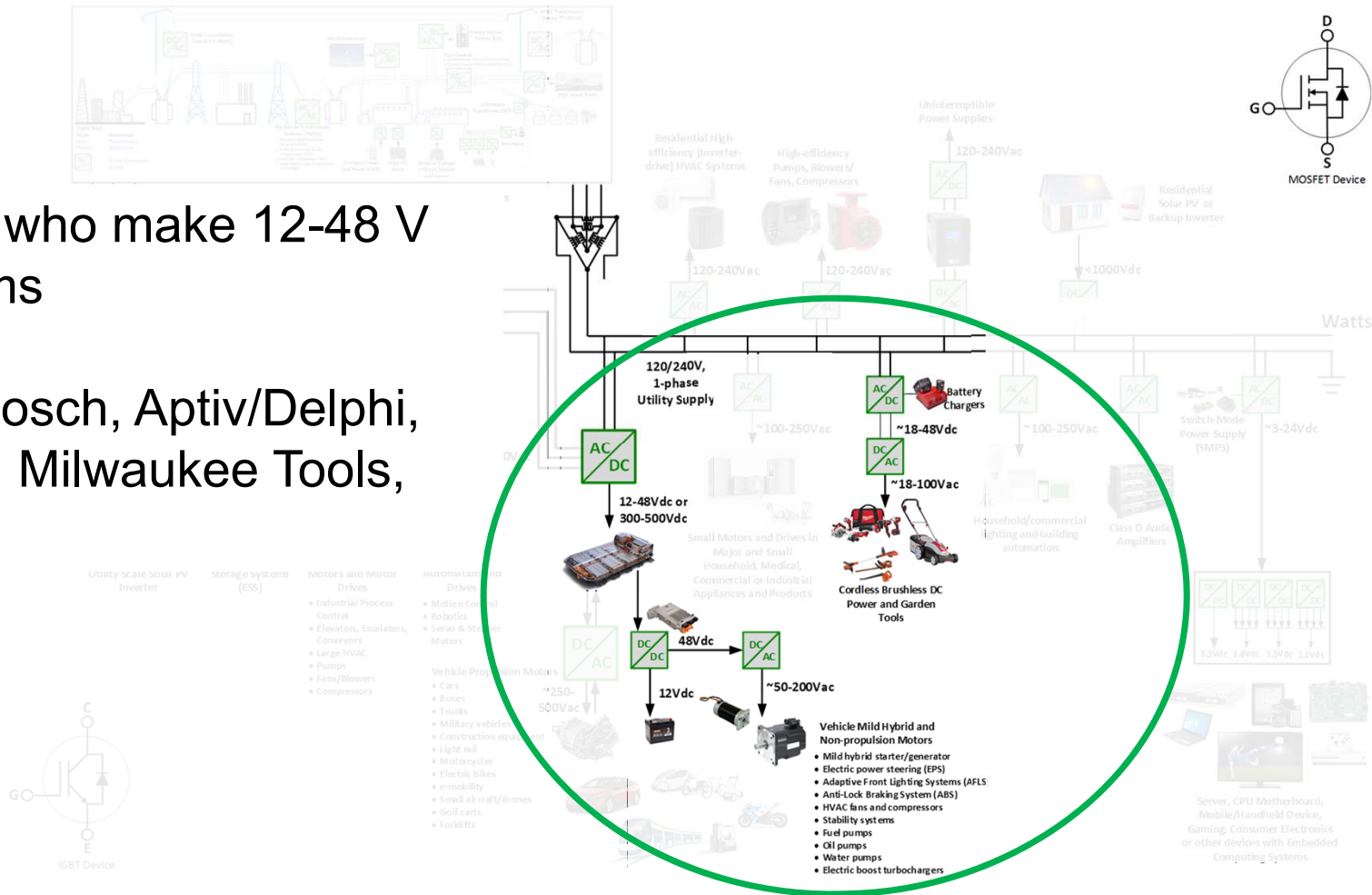

Target Application #1: 48 V Motors and Drives

Higher battery voltage requires higher common mode and peak voltage

How do the specs support this?

- 60 V common mode exceeds requirements during battery-charging
- 80 V (DC + peak AC) differential swing for overshoot events
- Low attenuation with multiple ranges for best noise performance

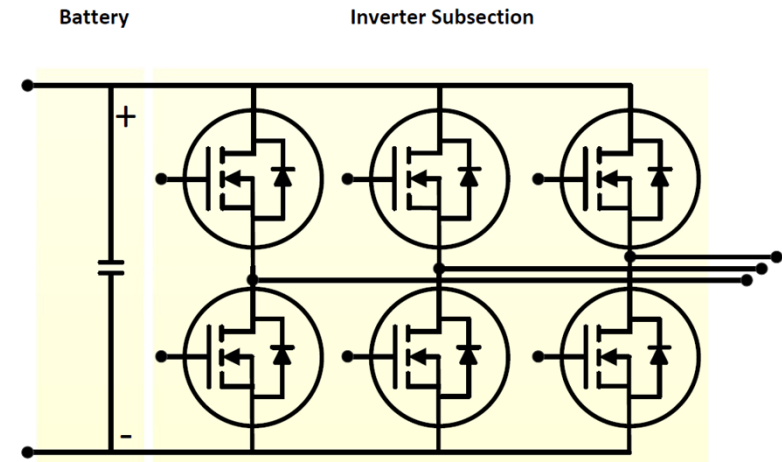

DC Bus or Battery Voltage	DC Battery Charging Voltage	Drive/Inverter Pulse-Width Modulated (PWM) Output			
		V _{pk} Line-Line or Line-Ref (Rated)		V _{pk} Line-Line or Line-Ref (with Overshoot)*	
		Operating	Charging	Operating	Charging
12	13.8	12	13.8	14.4	16.6
18	20.7	18	20.7	21.6	24.8
36	41.4	36	41.4	43.2	49.7
48	55.2	48	55.2	57.6	66.2
56	64.4	56	64.4	67.2	77.3

*assumes 20% signal overshoot

Target Application #2: High Power DC-DC Converters

Companies who make DC-DC Converters with 12-48 V DC inputs or outputs

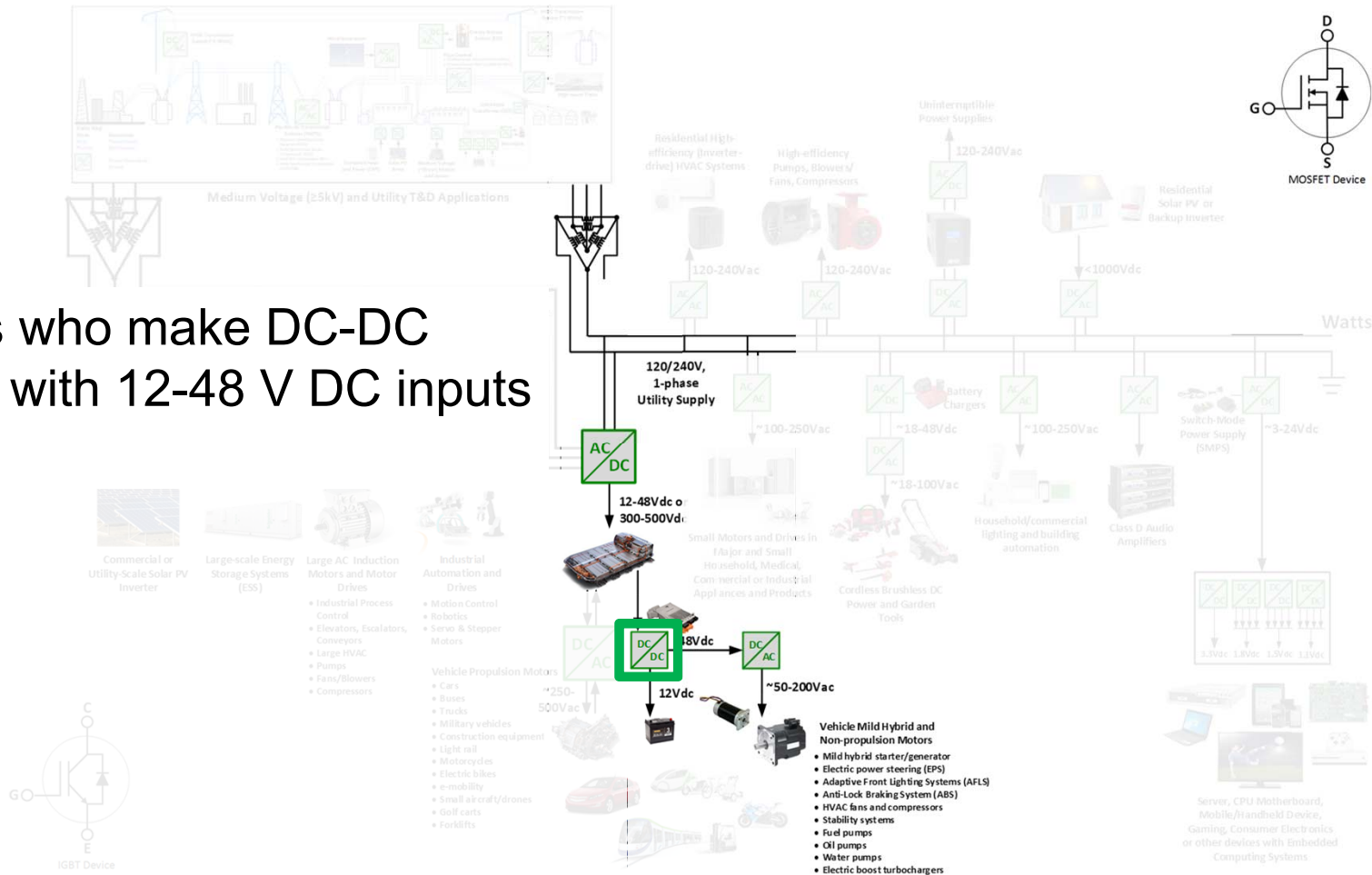

Target Application #2: High Power DC-DC Converters

- Used in server farm and vehicle applications
- DL-HCM probes provide the common mode and peak voltage needed for up to 60 V inputs
- Dynamic range to measure much smaller output voltages

How do the specs support this?

- 60 V common mode and offset ranges
- High-sensitivity (200 mV/div)
- 0.5% DC gain accuracy

Other Possible Target Applications

- GaN-based PDNs
 - Might be useful for measuring >5 V switching of Buck or Boost device in PDN DC-DC converter
- AC-DC switch-mode power supplies
 - Might be useful for measuring DC output voltage and ripple of GaN based switch-mode power supplies
- Wireless charging systems
 - First GaN-based applications
- Gate-drive measurements
 - Might be useful for measuring the upper side gate drive in ≤ 60 V GaN devices
 - 0.6 pF input capacitance should give very good result
- Shunt resistor measurements
 - **DL-HCM** probes have very low drift over temperature (**unlike AP033**), very low noise, and very good CMRR
 - 200 mV/div highest sensitivity might not be good enough

DL-HCM is an all-purpose probe

- Customers will want more than one probe
 - If they only want one, you should ask why
- A typical cascaded H-bridge could need as many as 5 DL-HCM probes, all for high side measurement
 - High Side Device Voltage (Qty 2)
 - Gate Drive Signal (Qty 2)
 - Line Voltage (Qty 1)

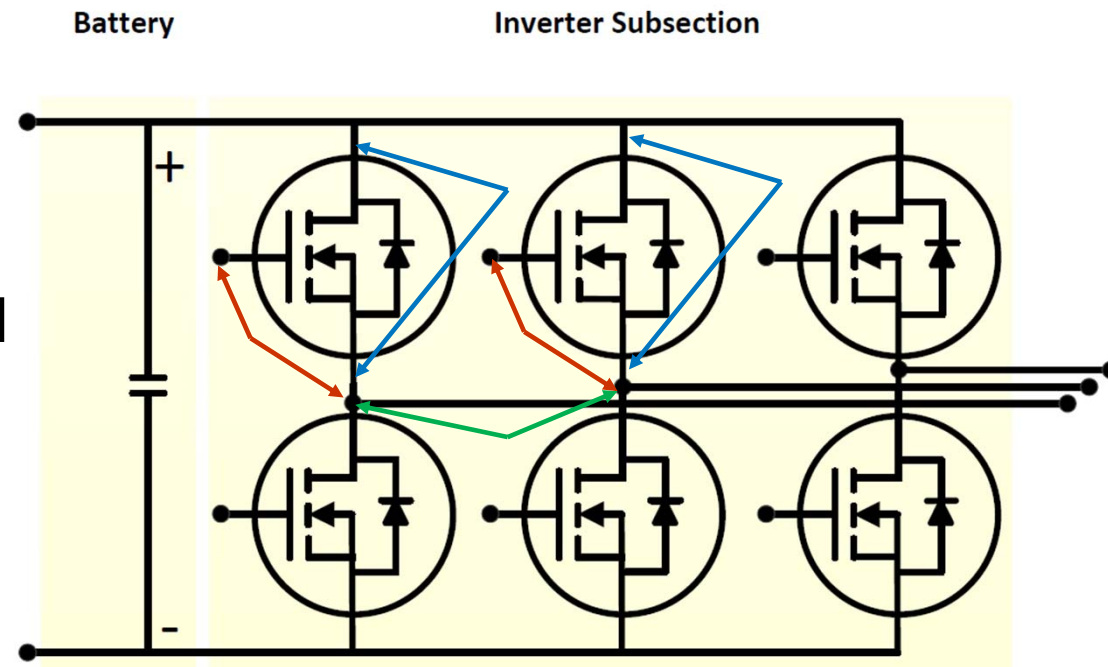

60 V Common Mode Differential Probes

Competitive Landscape



TELEDYNE LECROY
Everywhereyoulook™

DL-HCM – Highest Accuracy, Best Rejection, Lowest Noise

	Teledyne LeCroy DL05-HCM/ DL10-HCM	Rohde & Schwarz ZDx0 + ZA15	Keysight N2793A/ N2819A	Tektronix TDP500/ TDP1000
Bandwidth	500 MHz – 1 GHz	1 – 2.0 GHz	800 MHz	500 MHz – 1 GHz
Common mode range	±60 V	±22 V	±30 V	±35 V
Differential range	±80 V (DC + peak AC)	±60 V DC ±42.4 V AC (peak)	±20 V	±42 V (DC+ peak AC)
Gain accuracy	0.5%	0.8%	2%	2%
CMRR	80dB @ 10 kHz 70dB @ 100 kHz 50dB @ 100 MHz 35dB @ 500 MHz 30dB @ 1GHz	80dB @ 10kHz (after adjustment) 40dB @ 1 MHz 30dB @ 100 MHz 20 dB @ 1 GHz	60dB @ 50/60 Hz 15dB @ 500 MHz	55dB @ 30 kHz 50dB @ 1 MHz 18dB @ 250 MHz

R&S specs are not clear but it appears to be the closest competitor with a few key drawbacks.

- Differential signals will be clipped at ~60-72V – limited ability to make critical overshoot measurements
- R&S has less accuracy, more noise, and worse CMRR
- 2 GHz is overkill for these applications – 1 GHz is plenty for measuring the ripple

Tek and **Keysight** do not have a probe suitable for these measurements

- Not enough common mode and differential range

The AP033 is Still Useful for Lower Voltage Applications

- The AP033 can be thought of as “two probes in one” with four different effective gain ranges
 - ± 4.2 V Common mode with up to ± 400 mV differential input
 - ± 42 V Common mode with up to ± 40 V differential input
 - The DL-HCM targets this use-case with better specs

Effective Gain	Differential Input	Common Mode	Noise
x10	± 40 mV	± 4.2 V	0.14 mVrms
x1	± 400 mV	± 4.2 V	0.22 mVrms
x1	± 400 mV	± 42 V	1.34 mVrms
$\div 10$	± 4 V	± 42 V	2.57 mVrms
$\div 10$	± 40 V	± 42 V	25.7 mVrms



DL-HCM vs AP033

DL-HCM

- More bandwidth
- Higher common mode and differential range
- Better gain accuracy
- Better CMRR and lower noise at higher V/divs (< 1 V/div)

AP033

- Higher sensitivity
- Lower noise and better CMRR at lower V/divs (> 1 V/div)

	DL05-HCM DL10-HCM	AP033
Bandwidth	500 MHz – 1 GHz	500 MHz
Common mode range	±60 V	±42 V
Differential range	±80 V (DC+ peak AC)	±40 V
Gain accuracy	0.5%	2%
CMRR	80dB @ 10 kHz 70dB @ 100 kHz 50dB @ 100 MHz 35dB @ 500 MHz 30dB @ 1GHz	70dB @ 70Hz 60dB @ 1MHz 14dB @ 250MHz
Sensitivity	200 mV/div to 20 V/div	100 uV/div to 10 V/div
Noise (500 MHz)	200 mV - 1 V/div: 3.25mVrms 1.02 V - 2.5 V/div: 4.5mVrms 2.55 V - 20 V/div: 14.5mVrms	100 uV – 10mV/div: 14 mVrms 10 mV – 100 mV: 0.22 mVrms 100mV – 1 V: 2.57 mVrms 1 V – 10V/div: 25.7 mVrms
Price 500 MHz		
Price 1 GHz		N/A

The **AP033** has tradeoffs so you don't get all these specs at once. They depend on the effective gain setting

60 V Common Mode Differential Probes

Appendix A – Details on tips



TELEDYNE LECROY
Everywhereyoulook™

Wide Variety of Tips

Standard

- High performance solder-in (qty 2.)
- 2" solder-in tip
- Browser
- 2" y-lead
- 5" y-lead
- Single pin header (Qty. 2)
- Single pin (Qty. 6)
- Mini grabbers (Qty. 3)
- Ground lead
- New, clear case

Optional

- High temp solder-in (DL-HCM-HiTemp)
- Y-banana adaptor (DL-HCM-ACC-KIT)
- Micro grabber (DL-HCM-ACC-KIT)
- Probe Holder (DL-HCM-ACC-KIT)

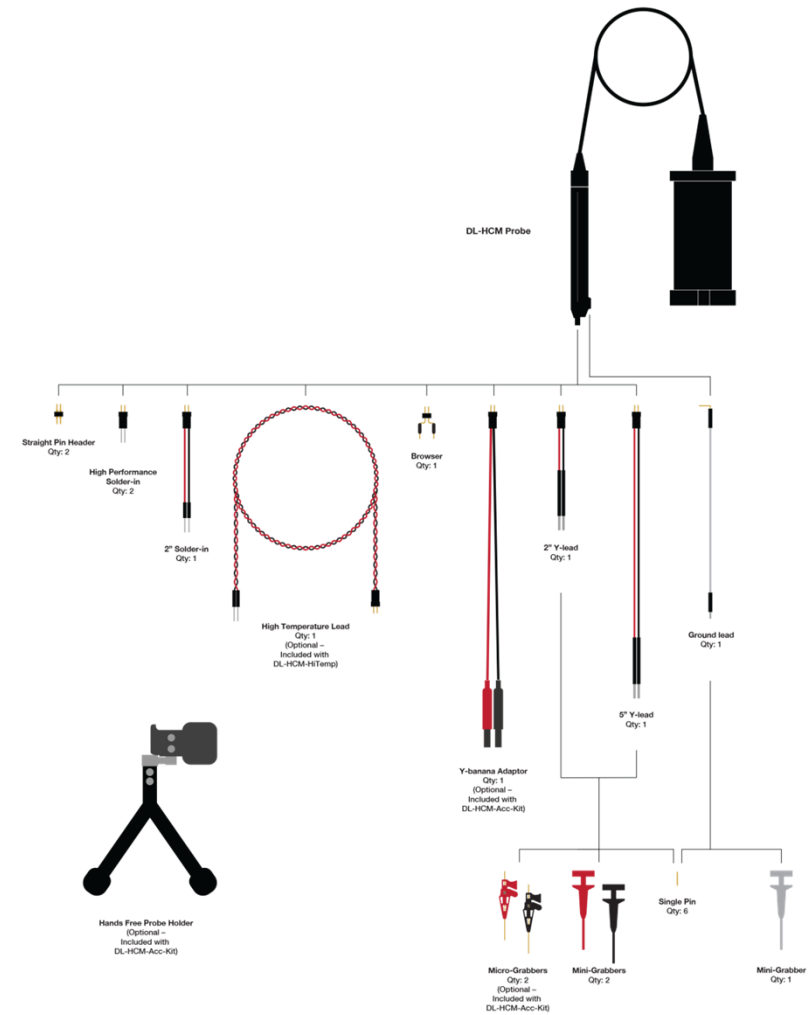

Wide Variety of Tips – High performance solder-in

Standard

- **High performance solder-in (qty 2.)**
- 2” solder-in tip
- Browser
- 2” and 5” y-lead
- Single pin header (Qty. 2)
- Single pin (Qty. 6)
- Mini grabbers (Qty. 3)
- Ground lead
- New, clear case



High Performance
Solder-in
Qty: 2

Optional

- High temp solder-in (DL-HCM-HiTemp)
- Y-banana adaptor (DL-HCM-ACC-KIT)
- Micro grabber (DL-HCM-ACC-KIT)
- Probe Holder (DL-HCM-ACC-KIT)

Wide Variety of Tips – 2” solder-in

Standard

- High performance solder-in (qty 2.)
- **2” solder-in tip**
- Browser
- 2” y-lead
- 5” y-lead
- Single pin header (Qty. 2)
- Single pin (Qty. 6)
- Mini grabbers (Qty. 3)
- Ground lead
- New, clear case

Optional

- High temp solder-in (DL-HCM-HiTemp)
- Y-banana adaptor (DL-HCM-ACC-KIT)
- Micro grabber (DL-HCM-ACC-KIT)
- Probe Holder (DL-HCM-ACC-KIT)



2” Solder-in
Qty: 1

Wide Variety of Tips – Browser

Standard

- High performance solder-in (qty 2.)
- 2” solder-in tip
- **Browser**
- 2” y-lead
- 5” y-lead
- Single pin header (Qty. 2)
- Single pin (Qty. 6)
- Mini grabbers (Qty. 3)
- Ground lead
- New, clear case

Optional

- High temp solder-in (DL-HCM-HiTemp)
- Y-banana adaptor (DL-HCM-ACC-KIT)
- Micro grabber (DL-HCM-ACC-KIT)
- Probe Holder (DL-HCM-ACC-KIT)



Browser
Qty: 1

Wide Variety of Tips – Browser

New design so tips hold position better (unlike ZD probes)



Wide Variety of Tips – 2” y-lead

Standard

- High performance solder-in (qty 2.)
- 2” solder-in tip
- Browser
- **2” y-lead**
- 5” y-lead
- Single pin header (Qty. 2)
- Single pin (Qty. 6)
- Mini grabbers (Qty. 3)
- Ground lead
- New, clear case

Optional

- High temp solder-in (DL-HCM-HiTemp)
- Y-banana adaptor (DL-HCM-ACC-KIT)
- Micro grabber (DL-HCM-ACC-KIT)
- Probe Holder (DL-HCM-ACC-KIT)



2” Y-lead
Qty: 1

Wide Variety of Tips – 5” y-lead

Standard

- High performance solder-in (qty 2.)
- 2” solder-in tip
- Browser
- 2” y-lead
- **5” y-lead**
- Single pin header (Qty. 2)
- Single pin (Qty. 6)
- Mini grabbers (Qty. 3)
- Ground lead
- New, clear case

Optional

- High temp solder-in (DL-HCM-HiTemp)
- Y-banana adaptor (DL-HCM-ACC-KIT)
- Micro grabber (DL-HCM-ACC-KIT)
- Probe Holder (DL-HCM-ACC-KIT)



5” Y-lead
Qty: 1

Wide Variety of Tips – Single pin header

Standard

- High performance solder-in (qty 2.)
- 2" solder-in tip
- Browser
- 2" y-lead
- 5" y-lead
- **Single pin header (Qty. 2)**
- Single pin (Qty. 6)
- Mini grabbers (Qty. 3)
- Ground lead
- New, clear case

Optional

- High temp solder-in (DL-HCM-HiTemp)
- Y-banana adaptor (DL-HCM-ACC-KIT)
- Micro grabber (DL-HCM-ACC-KIT)
- Probe Holder (DL-HCM-ACC-KIT)



Straight Pin Header
Qty: 2

Wide Variety of Tips – Single pin

Standard

- High performance solder-in (qty 2.)
- 2” solder-in tip
- Browser
- 2” y-lead
- 5” y-lead
- Single pin header (Qty. 2)
- **Single pin (Qty. 6)**
- Mini grabbers (Qty. 3)
- Ground lead
- New, clear case

Optional

- High temp solder-in (DL-HCM-HiTemp)
- Y-banana adaptor (DL-HCM-ACC-KIT)
- Micro grabber (DL-HCM-ACC-KIT)
- Probe Holder (DL-HCM-ACC-KIT)



Wide Variety of Tips – Mini grabbers

Standard

- High performance solder-in (qty 2.)
- 2” solder-in tip
- Browser
- 2” y-lead
- 5” y-lead
- Single pin header (Qty. 2)
- Single pin (Qty. 6)
- **Mini grabbers (Qty. 3)**
- Ground lead
- New, clear case

Optional

- High temp solder-in (DL-HCM-HiTemp)
- Y-banana adaptor (DL-HCM-ACC-KIT)
- Micro grabber (DL-HCM-ACC-KIT)
- Probe Holder (DL-HCM-ACC-KIT)

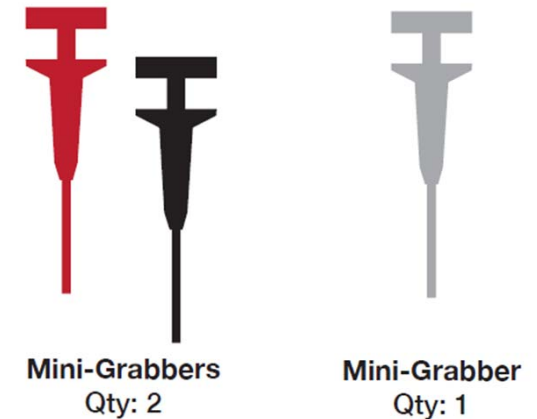

Wide Variety of Tips – Ground Lead

Standard

- High performance solder-in (qty 2.)
- 2" solder-in tip
- Browser
- 2" y-lead
- 5" y-lead
- Single pin header (Qty. 2)
- Single pin (Qty. 6)
- Mini grabbers (Qty. 3)
- **Ground lead**
- New, clear case

Optional

- High temp solder-in (DL-HCM-HiTemp)
- Y-banana adaptor (DL-HCM-ACC-KIT)
- Micro grabber (DL-HCM-ACC-KIT)
- Probe Holder (DL-HCM-ACC-KIT)



Wide Variety of Tips – New Clear Case

Easy to see what tips are inside of the case



Wide Variety of Tips – New Clear Case

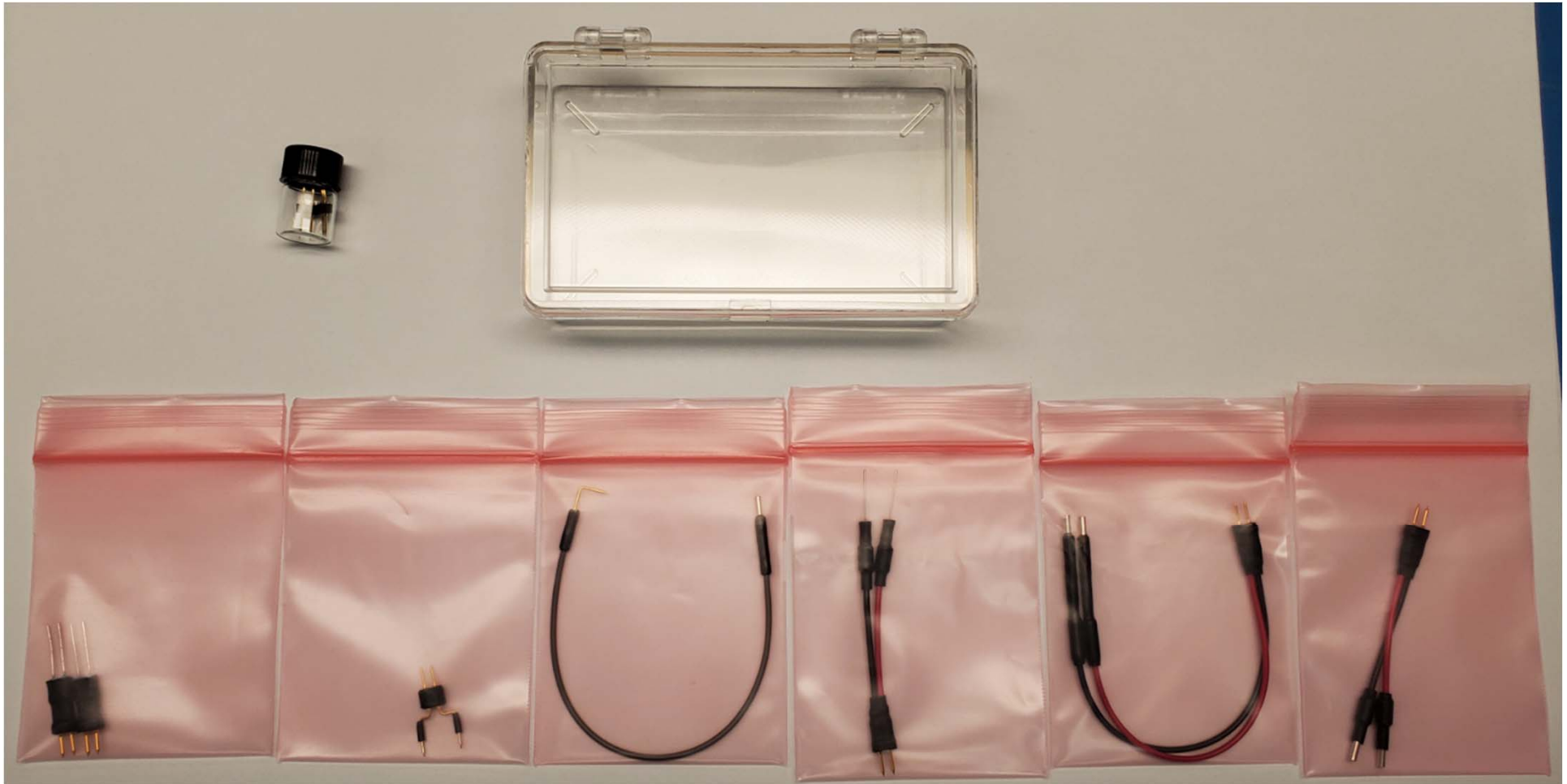

Wide Variety of Tips – High temp solder-in

Standard

- High performance solder-in (qty 2.)
- 2" solder-in tip
- Browser
- 2" y-lead
- 5" y-lead
- Single pin header (Qty. 2)
- Single pin (Qty. 6)
- Mini grabbers (Qty. 3)
- Ground lead
- New, clear case

Optional

- **High temp solder-in (DL-HCM-HiTemp)**
- Y-banana adaptor (DL-HCM-ACC-KIT)
- Micro grabber (DL-HCM-ACC-KIT)
- Probe Holder (DL-HCM-ACC-KIT)

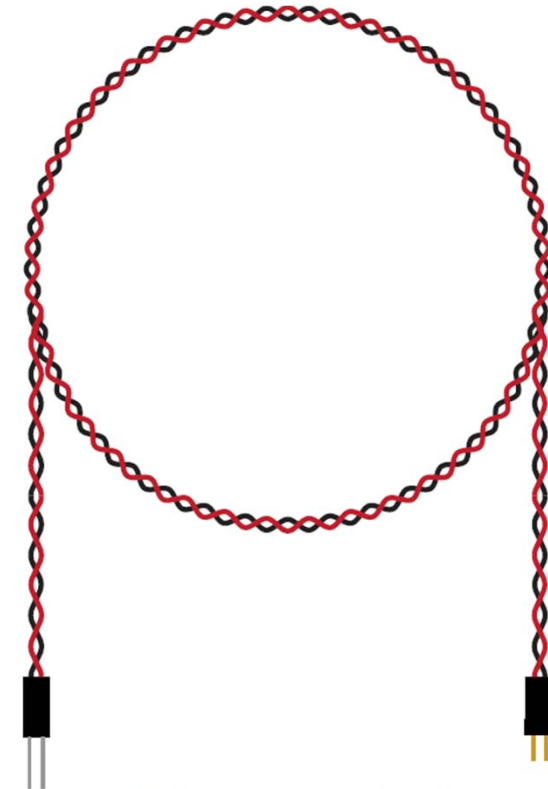

High Temperature Lead
Qty: 1
(Optional –
Included with
DL-HCM-HiTemp)

Wide Variety of Tips – Y-banana adaptor

Standard

- High performance solder-in (qty 2.)
- 2" solder-in tip
- Browser
- 2" y-lead
- 5" y-lead
- Single pin header (Qty. 2)
- Single pin (Qty. 6)
- Mini grabbers (Qty. 3)
- Ground lead
- New, clear case

Optional

- High temp solder-in (DL-HCM-HiTemp)
- **Y-banana adaptor (DL-HCM-ACC-KIT)**
- Micro grabber (DL-HCM-ACC-KIT)
- Probe Holder (DL-HCM-ACC-KIT)



Y-banana Adaptor
Qty: 1
(Optional –
Included with
DL-HCM-Acc-Kit)

Wide Variety of Tips – Y-banana adaptor

Standard

- High performance solder-in (qty 2.)
- 2" solder-in tip
- Browser
- 2" y-lead
- 5" y-lead
- Single pin header (Qty. 2)
- Single pin (Qty. 6)
- Mini grabbers (Qty. 3)
- Ground lead
- New, clear case

Optional

- High temp solder-in (DL-HCM-HiTemp)
- **Y-banana adaptor (DL-HCM-ACC-KIT)**
- Micro grabber (DL-HCM-ACC-KIT)
- Probe Holder (DL-HCM-ACC-KIT)



Y-banana Adaptor
Qty: 1
(Optional –
Included with
DL-HCM-Acc-Kit)

Wide Variety of Tips – Y-banana adaptor

Standard

- High performance solder-in (qty 2.)
- 2” solder-in tip
- Browser
- 2” y-lead
- 5” y-lead
- Single pin header (Qty. 2)
- Single pin (Qty. 6)
- Mini grabbers (Qty. 3)
- Ground lead
- New, clear case

Optional

- High temp solder-in (DL-HCM-HiTemp)
- Y-banana adaptor (DL-HCM-ACC-KIT)
- **Micro grabber (DL-HCM-ACC-KIT)**
- Probe Holder (DL-HCM-ACC-KIT)



Micro-Grabbers
Qty: 2
(Optional –
Included with
DL-HCM-Acc-Kit)

Wide Variety of Tips – Y-banana adaptor

Standard

- High performance solder-in (qty 2.)
- 2" solder-in tip
- Browser
- 2" y-lead
- 5" y-lead
- Single pin header (Qty. 2)
- Single pin (Qty. 6)
- Mini grabbers (Qty. 3)
- Ground lead
- New, clear case

Optional

- High temp solder-in (DL-HCM-HiTemp)
- Y-banana adaptor (DL-HCM-ACC-KIT)
- Micro grabber (DL-HCM-ACC-KIT)
- **Probe Holder (DL-HCM-ACC-KIT)**

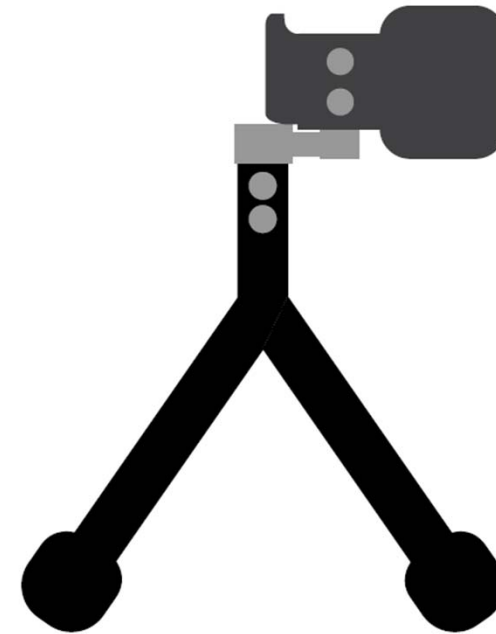

Hands Free Probe Holder
(Optional –
Included with
DL-HCM-Acc-Kit)

Probe Holder

The probe holder has the same base as the DH probes, with a different holder for the probe



60 V Common Mode Differential Probes

Appendix B – Other useful info



TELEDYNE LECROY
Everywhereyoulook™

Qualify opportunity before recommending a probe to customer

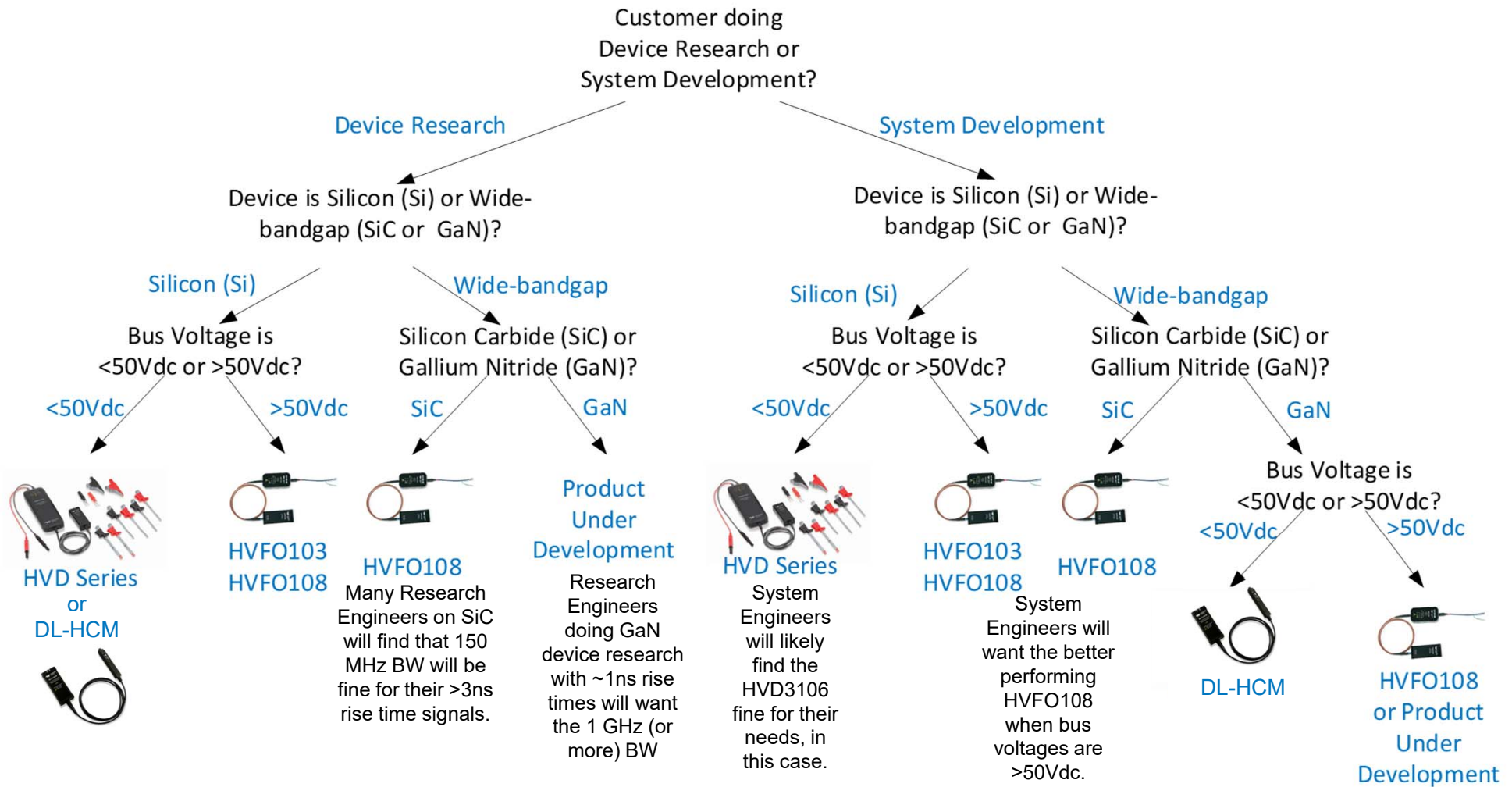

Highest Accuracy – Precision Gain Calibration

- Improves gain calibration in current measurement configuration (removes the DC gain drift over temperature)
 - Also performs autozero
- Calibrations are cached (up to 100) for each V/div, bandwidth setting and temperature range (± 5 °C)
- UI indications is Precision Gain Calibration is in use

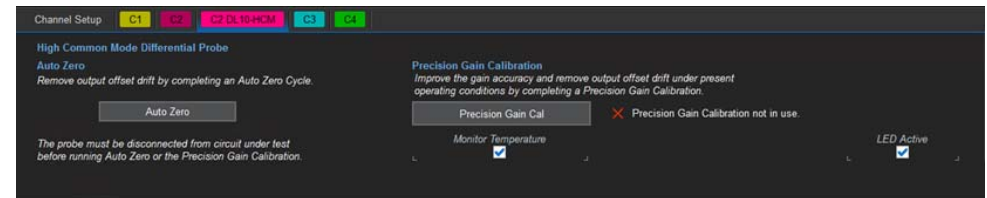
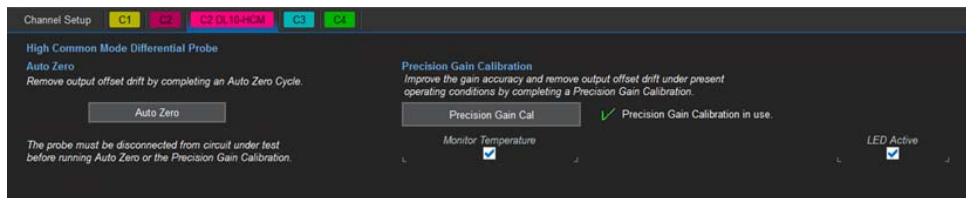

Highest Accuracy – 0.5% Gain Accuracy and Best LF Flatness

- Provides for high accuracy of top and base voltage levels of pulse-width modulated signals

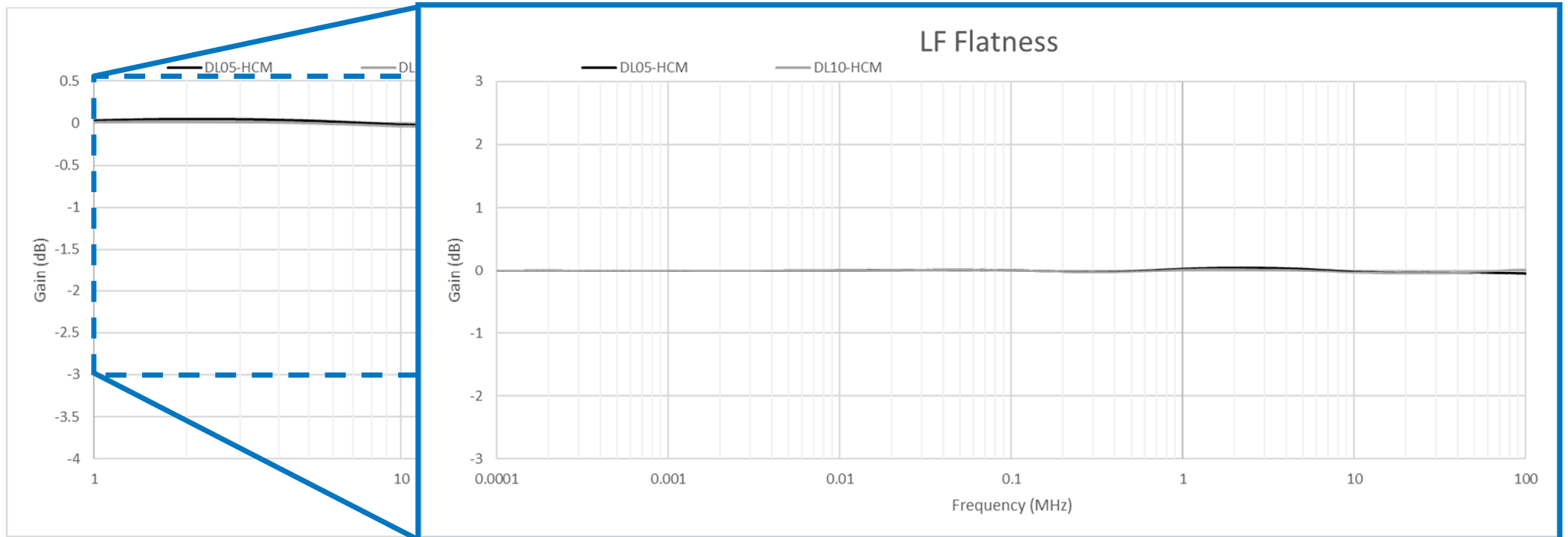

Lowest Noise and Highest Rejection

- High CMRR to very high frequencies
 - Best measurement performance when measuring very fast slew rate (high dV/dt) PWM signals typical of GaN devices and systems
- Exceptional CMRR combined with low probe noise and high offset
 - Great for very small control signals floating on high common mode voltages

