

## Industrial flue gas probes

Instruction manual



---

# 1 Contents

<b>1</b>	<b>Contents .....</b>	<b>3</b>
<b>2</b>	<b>Safety and the environment.....</b>	<b>4</b>
	2.1. About this document.....	4
	2.2. Ensure safety.....	4
	2.3. Protecting the environment.....	5
<b>3</b>	<b>Specifications .....</b>	<b>6</b>
	3.1. Use .....	6
	3.2. Technical data .....	7
<b>4</b>	<b>Product description.....</b>	<b>11</b>
<b>5</b>	<b>Using the product.....</b>	<b>13</b>
<b>6</b>	<b>Maintaining the product.....</b>	<b>15</b>
	6.1. Checking / cleaning / replacing the particle filter.....	15
	6.2. Cleaning / replacing the preliminary filter.....	18
	6.3. Cleaning / replacing metal sampling tube .....	20
	6.4. Cleaning / replacing the ceramic tube .....	21
	6.5. Replacing unheated gas sampling hose.....	22
	6.6. Cleaning the gas path in the probe handle .....	23
	6.7. Replacing the thermocouple.....	27
<b>7</b>	<b>Tips and assistance.....</b>	<b>30</b>
	7.1. Recommendations and application instructions.....	30
	7.2. Tightening torques for screw connections .....	30
	7.3. Accessories and spare parts .....	31

## 2 Safety and the environment

### 2.1. About this document

#### Use

- > Please read this documentation through carefully and familiarize yourself with the product before putting it to use. Pay particular attention to the safety instructions and warning advice in order to prevent injuries and damage to the products.
- > Keep this document to hand so that you can refer to it when necessary.
- > Hand this documentation on to any subsequent users of the product.

### 2.2. Ensure safety



#### CAUTION

##### **Danger of burning on hot surfaces!**

- > Always wear heat-resistant gloves when touching the probe shaft.
  - > Allow the probe shaft to cool down after a measurement, before touching it or placing it in the transport packaging.
- 
- > Only operate the product properly, for its intended purpose and within the parameters specified in the technical data. Do not use any force.
  - > Temperatures given on probes/sensors relate only to the measuring range of the sensors. Do not expose handles and feed lines to any temperatures in excess of 70 °C unless they are expressly permitted for higher temperatures.
  - > Do not operate the instrument if there are signs of damage at the housing, mains unit or feed lines.
  - > Do not perform contact measurements on non-insulated, live parts.
  - > Do not store the product together with solvents. Do not use any desiccants.
  - > Only perform maintenance and repair work on this instrument that is described in the documentation. Follow the prescribed steps exactly. Use only original spare parts from Testo.

- > Any additional work must only be carried out by authorized personnel. Testo will otherwise refuse to accept responsibility for the proper functioning of the measuring instrument after repair and for the validity of certifications.
- > The industrial flue gas probe must not be used in explosive environments.
- > When connecting the heated industrial flue gas probe, ensure correct mains voltage as specified on the type plate.
- > Before opening the probe housing of the heated industrial flue gas probe, pull out the mains plug.

#### Safety-related symbols on heated industrial flue gas probes

Symbol	Explanation
	<p>If the product is not used in strict compliance with this documentation, the intended protection may be impaired.</p> <ul style="list-style-type: none"> <li>&gt; Operate the product only as described in this documentation.</li> <li>&gt; Please consult your dealer or the manufacturer if in doubt.</li> </ul>
	Risk of burns due to hot surface.
	Use heat-resistant gloves for protection against harmful thermal effects.

## 2.3. Protecting the environment

- > At the end of its useful life, send the product to the separate collection for electric and electronic devices (observe local regulations) or return the product to Testo for disposal.

## 3 Specifications

### 3.1. Use

The industrial flue gas probes have been designed for the following tasks / applications:

- Extractive sampling of the flue gas being analyzed at industrial plants with
  - high temperatures of > 1000 °C
  - large sampling diameters
  - wet flue gas to prevent distorted readings (heated industrial flue gas probe up to 600 °C)

The industrial flue gas probes are used in conjunction with the following flue gas analyzers:

- testo 340
- testo 350

The industrial flue gas probes come in two pre-configured sets. A system-specific sampling solution can be put together using other accessories.

## 3.2. Technical data

### General

Feature	Values
Overpressure in the flue gas	max. 100 mbar
Negative pressure in the flue gas	testo 340: max. 200 mbar testo 350: max. 300 mbar
Ambient temperature	-5 to +45 °C
Storage temperature	-20 to +50 °C

### Unheated handle (item no. 0440 0649)

Feature	Values
Temperature resistance	600 °C
Handle - probe shaft connection	Internal thread G 1/4
Handle - thermocouple connection	Internal thread M8 x 1
Hose connection	Adapter with hose nozzle, 7 mm outer diameter
Material	Stainless steel 1,4404

### Unheated gas sampling hose (item no. 0554 3354)

Feature	Values
Length	4000 mm
Design	2-chamber hose with Teflon inner hose
Particle filter	To protect the measuring instrument from particulate matter and dirt Material: PE porous 10 µm

**Unheated sampling tube up to 1200 °C (item no. 0600 7617)**

<b>Feature</b>	<b>Values</b>
Temperature resistance	1200 °C
Dimensions	Length 1053 mm, Probe shaft: Ø 12 mm, Threaded socket: Ø 17 mm
Connection	Thread G 1/4
Material	2.4856 alloy 625
Option	Probe extension (extension tube item no. 0600 7617) Probe preliminary filter (item no. 0600 7616) can be attached

**Unheated sampling tube up to 1800 °C (item no. 0600 7805)**

<b>Feature</b>	<b>Values</b>
Temperature resistance	1800 °C
Dimensions	Ø 12 mm, length 1000 mm
Handle	Adapter with O-ring, Tmax: 220 °C; Ø 22 mm
Material	Ceramic Al <sub>2</sub> O <sub>3</sub> >99.7%

**Thermocouple (item no. 0430 0088)**

<b>Feature</b>	<b>Values</b>
Temperature recorder	Type K NiCr-Ni, insulated Class 1
Sheathed cable	2.4816 alloy 600
Length TC	1200 mm; optional length 2200 mm (item no. 0600 7615) available
Diameter	2 mm
Measuring range	-200 to +1200 °C
Cable length	4.0 m



**Heated sampling tube (item no. 0600 3502)**

Feature	Values
Temperature resistance	up to 600 °C
Voltage supply	230 V/50 Hz
Power consumption	400 W
Dimensions	Ø 25 mm, length: 1110 mm
Ready for operation	within 15 min.
Heating temperature	>180 °C
Option	Probe extension (extension tube) (item no. 0600 7617) Probe preliminary filter (item no. 0600 7616) can be attached

**Heated gas sampling hose (item no. 0600 3501)**

Feature	Values
Design	Corrugated hose with Teflon inner hose
Dimensions	Length: 4000 mm Corrugated hose: Ø 28 mm Silicone caps: Ø 34 mm
Heating temperature range	>120 °C
Ready for operation	within 15 min.
Outside temperature	max. +45 °C
Voltage supply	230 V/50 Hz
Power consumption	160 W
Bending radius	min. 200 mm

**Preliminary filter (item no. 0600 7616)**

Feature	Values
Operating temperature	max. 1000 °C
Dimensions	Ø 32.6 mm, length 110 mm
Filter seat	Material: 1.4841 Connecting thread: G 1/4

<b>Feature</b>	<b>Values</b>
Filter nut	Material: 1.4841 Thread: G 1/4
Filter element	Dimensions: Ø 30 mm, length 75 mm Material: porous silicon carbide Particle size: 10 µm
Filtration grade for gases	2 µm
Safety cotter pin	DIN 94, dimensions: 2.0 x 16 mm, Material: stainless steel A4

#### **Warranty**

<b>Feature</b>	<b>Values</b>
Thermocouple	12 months
Heated sampling tube	24 months
Heated hose	24 months
Sampling / extension tube	24 months
Unheated hose	24 months
Unheated handle	24 months
Warranty terms	see website <a href="http://www.testo.com/warranty">www.testo.com/warranty</a>

## 4 Product description

### Industrial flue gas probe set 1200 °C (0600 7610)

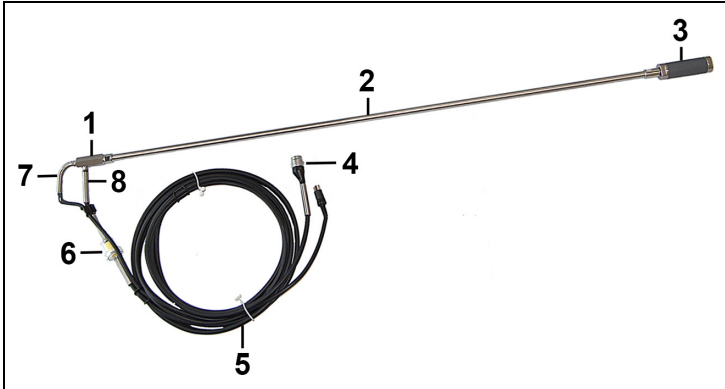

1	Unheated handle
2	Unheated metal sampling tube
3	Preliminary filter (optional)
4	Instrument connections
5	Unheated gas sampling hose
6	Particle filter
7	Thermocouple type K
8	Gas path

**Industrial flue gas probe set 1.800 °C (0600 7620)**

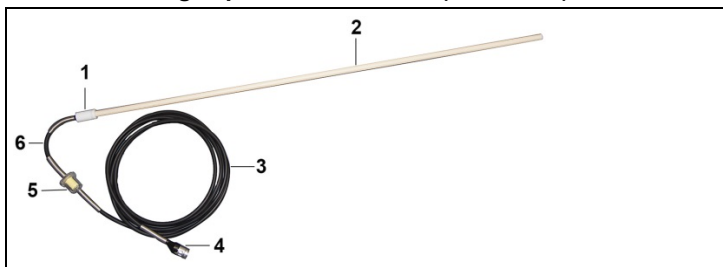

1	Unheated handle
2	Unheated ceramic sampling tube
3	Unheated gas sampling hose
4	Instrument connection
5	Particle filter
6	Gas path

**Industrial flue gas probe set, heated (0600 7630)**

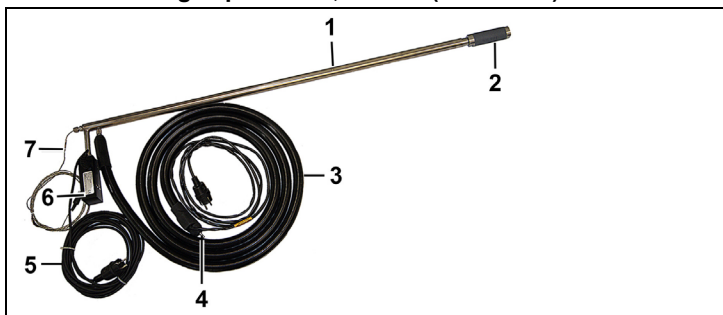

1	Heated sampling tube
2	Preliminary filter (optional)
3	Heated gas sampling hose
4	Instrument connection
5	Probe heater connection cable
6	Probe heater
7	Thermocouple type K

## 5 Using the product

### Heated industrial flue gas probe

- i** > The heated industrial flue gas probe is designed for a mains voltage of 230 V!
  - > Uncoil the coiled gas sampling hose correctly so that there is no torsional strain.
  - > Lay the gas sampling hose so that it is protected from the wind and the weather, because depending on the wind/weather conditions, there is considerable loss of heat at the outer sheath.
  - > When installing in closed rooms please ensure that there is sufficient ventilation to prevent heat build-up.
  - > To prevent damage
    - Do not route the gas sampling hose over sharp edges or via feedthroughs.
    - When securing, make sure that the gas sampling hose is not squashed.
    - There should be no moving or bending stresses on the connections themselves. When installing, please ensure a minimum bending radius of 200 mm.
  - > Following final installation, visually inspect the heated industrial flue gas probe for any damage.
  - > After the mains plug has been plugged in, the total heating up time is approx. 20 minutes.
  - > Once the heating up time has elapsed, the heated sampling tube is very hot and should only be touched with heat-resistant gloves.

#### CAUTION

#### **Danger of burning on hot surfaces!**

- > Always wear heat-resistant gloves when touching the probe shaft.
- > Allow the probe shaft to cool down after a measurement, before touching it or placing it in the transport packaging.

**Checking the thermocouple**

- > Make sure that the thermocouple of the industrial flue gas probe does not touch the probe shaft. Bend the thermocouple back if necessary.

**Aligning the industrial flue gas probe**

- > Align the industrial flue gas probe in the flue gas duct so that the tip is in the centre of flow (area of the highest flue gas temperature).

Optional

- Mount extension tube.
- Mount preliminary filter.
- Install thermocouple 2200 mm.

## 6 Maintaining the product

### 6.1. Checking / cleaning / replacing the particle filter

#### Checking the particle filter:

Check the particle filter of the industrial flue gas probe regularly for

- Damage to and contamination of the housing
- Filter saturation of the PE filter

Visual inspection

#### Cleaning the particle filter housing:

- > If there are any signs of contamination, clean the particle filter housing.

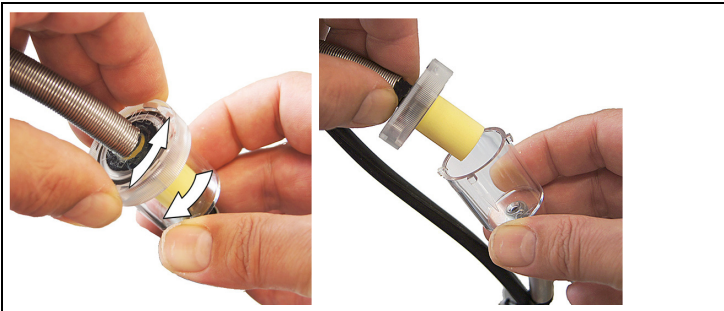

1. Open the filter cover of the housing
2. Remove dirt using a cloth.
3. Put the filter cover on and lock it: turn slightly clockwise

**Replacing the particle filter housing:**

- > In the event of any damage to the housing, replace the particle filter (item no. 0440 0668).



1. Remove bend protection springs and hose connections from the particle filter by turning clockwise.
2. Attach new particle filter to the hose connections.

---

**i** If the saturation level is low, the PE filter can be inserted in the new housing.

---

3. Push the bend protection springs over the hose connections by pressing and simultaneously turning clockwise.

**Checking the PE filter:**

Check the particle filter of the industrial flue gas probe regularly for filter saturation.

Carry out a test.

- Measuring instrument is switched on.



- > Remove bend protection spring and hose connection from the particle filter by turning clockwise.
- The measurement gas pump now sucks in ambient air via the filter. Filter needs replacing if:
  - Flow rate < 0.6 l/min testo 350
  - Flow rate < 0.2 l/min testo 340



- 
- i** If the flow rate value is  $>0.6$  l/min (testo 350) or  $> 0.2$  l/min (testo 340), the particle filter is not yet saturated. We recommend checking the handle, the preliminary filter and the sampling tube.
- 

**Replacing the PE filter:**

> If the PE filter is visibly saturated: replace the PE filter.

1. Open the filter cover of the housing

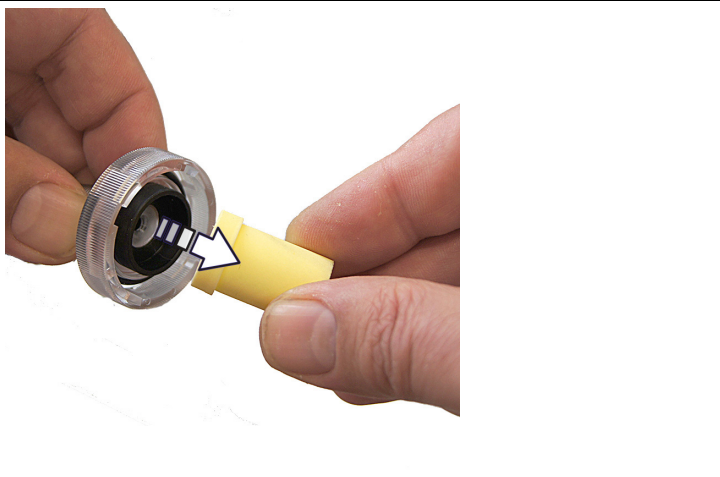

2. Remove the spent PE filter.
3. Insert new PE filter. Insert the PE filter into the filter holder as far as it will go.
4. Put the filter cover on and lock it: turn slightly clockwise.

## 6.2. Cleaning / replacing the preliminary filter

Check the preliminary filter of the industrial flue gas probe regularly for contamination: visual inspection

> In the event of any visible contamination, clean or replace the preliminary filter.

1. Fix the sampling tube securely in place.

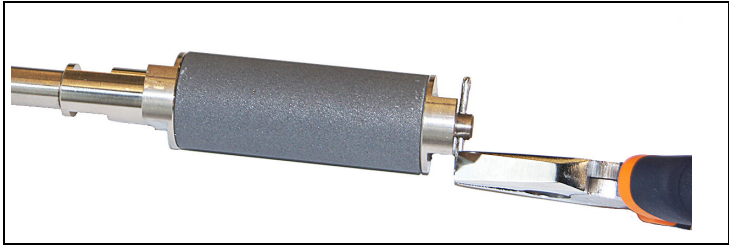

2. Press the ends of the safety cotter pin together with pliers and slide upwards.

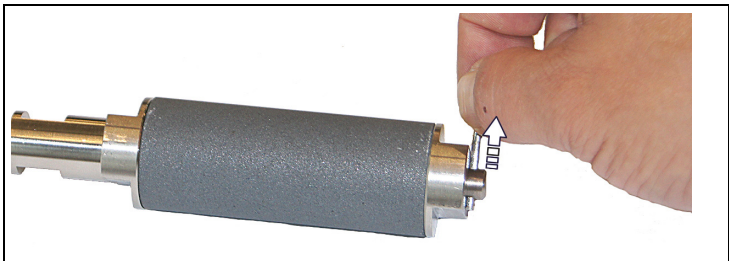

3. Remove safety cotter pin.

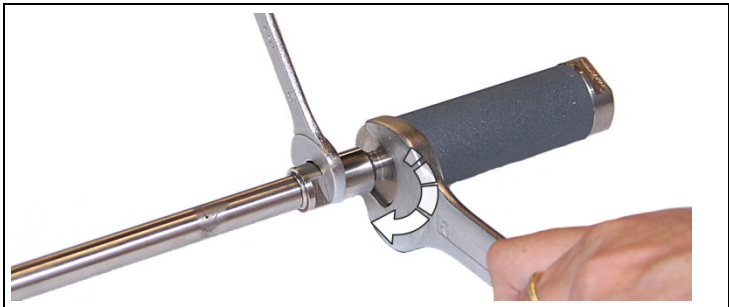

4. Remove the preliminary filter (size SW17) from the sampling tube (size SW13) using wrenches.

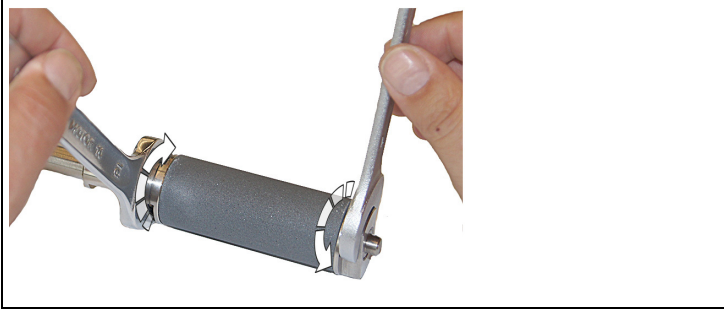

5. Open preliminary filter using wrenches (size SW17).

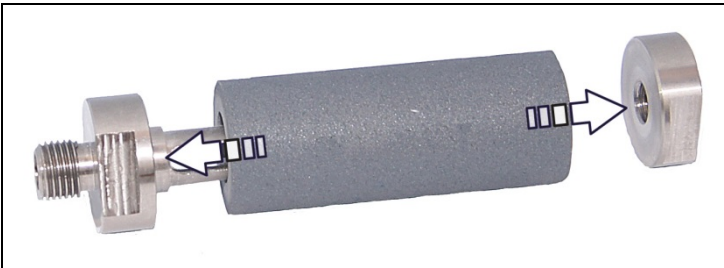

6. Remove screw connections from the preliminary filter.
7. Clean the preliminary filter.

#### ATTENTION

Do not clean preliminary filter in liquids or ultrasonically.

#### Damage due to improper cleaning!

- > Soot or particle deposits on the preliminary filter can be brushed off using a wire brush. Then blow compressed air through the preliminary filter.

8. Put together, screw together and tighten the cleaned or new preliminary filter and insert safety cotter pin, see Tightening torques for screw connections, page 30.



It is recommended that the thread of the prefilter to grease with a commercial ceramic paste.

9. Tighten the preliminary filter (size SW17) on the sampling tube (size SW13) using wrenches, see Tightening torques for screw connections, page 30.
10. Disengage the sampling tube.

### 6.3. Cleaning / replacing metal sampling tube

Check the sampling tube of the industrial flue gas probe regularly for contamination: visual inspection

- > In the event of any visible contamination, clean or replace the sampling tube.

**⚠ CAUTION**

Hot probe shaft!

**Risk of burns!**

- > Allow the probe shaft to cool down before you touch or pack it!

1. Fix the sampling tube securely in place.

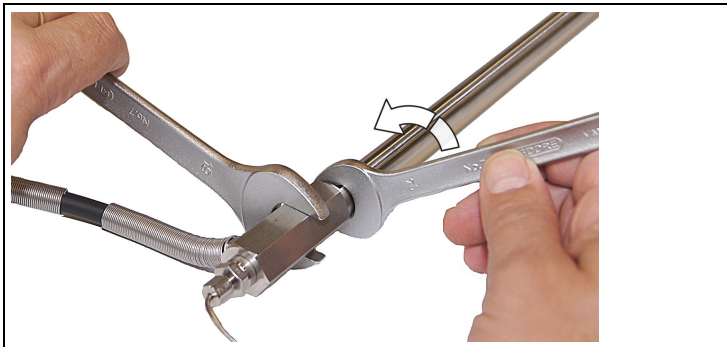

2. Remove the sampling tube (size SW13) from the handle (size SW19) using wrenches.

---

**i** If necessary remove preliminary filter from the sampling tube.

3. Cleaning the sampling tube

- > Brush off soot or particle deposits on the sampling tube using a wire brush.
- > Scrape out the inside of the sampling tube using a sturdy wire (e.g. Ø 3 mm). Hold the tube at a slight angle, so that the dislodged particles fall out.
- > Then blow compressed air through the sampling tube.

4. Screw cleaned or new sampling tube onto the handle and tighten, see Tightening torques for screw connections, page 30.

---

**i** If necessary screw preliminary filter onto the sampling tube.

5. Disengage the sampling tube.

## 6.4. Cleaning / replacing the ceramic tube

Check the sampling tube of the industrial flue gas probe regularly for contamination: visual inspection

- > In the event of any visible contamination, clean or replace the sampling tube.

### **⚠ CAUTION**

Hot probe shaft!

#### **Risk of burns!**

- > Allow the probe shaft to cool down before you touch or pack it!

### **⚠ CAUTION**

#### **Fragile ceramic sampling tube!**

- > Avoid mechanical loads.

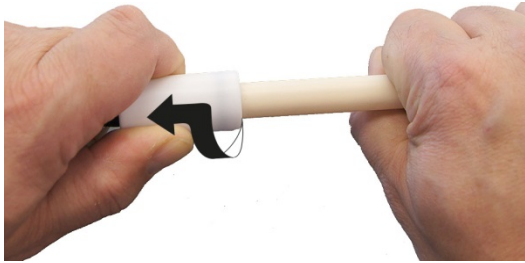

1. Remove sampling tube from the handle.
2. Cleaning the sampling tube
  - > Scrape out the inside of the sampling tube using a sturdy wire (e.g. Ø 3 mm). Hold the tube at a slight angle, so that the dislodged particles fall out.
  - > Then blow compressed air through the sampling tube.
3. Check handle
  - If the O-ring in the handle is damaged, the handle must be replaced.
4. Insert a cleaned or new sampling tube into the handle as far as it will go.

## 6.5. Replacing unheated gas sampling hose

Check the unheated gas sampling hose of the industrial flue gas probe regularly for damage and contamination: visual inspection

### Replacing the gas sampling hose

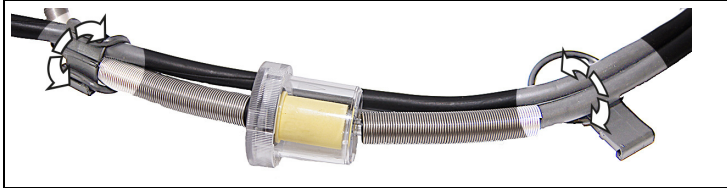

1. Undo all hose clamps on the gas sampling hose.
2. Remove all bend protection springs from the hose connections and the thermocouple clamping screw by turning clockwise.
3. Remove hose connections from the particle filter, gas path connection and gas path plug by turning clockwise.
4. Remove bend protection springs from the hose connections.



5. Undo the thermocouple clamping screw connection.
6. Pull the thermocouple approx. 100 mm out of the probe handle.
7. Push bend protection spring over the thermocouple.
8. Remove the thermocouple cable, starting at the instrument plug, from the slotted tube.
9. Insert the thermocouple cable, starting at the instrument plug, into the slotted tube of the new gas sampling hose.
10. Push the bend protection spring over the slotted tube.

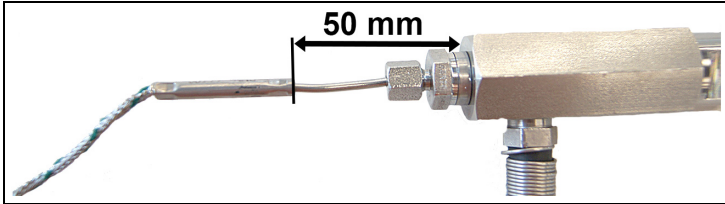

11. Carefully thread the thermocouple up to 50 mm through the clamping screw and the probe handle into the probe shaft.
12. Tighten clamping screw using a wrench (size SW8), with 1 3/4 turns.



When refitting the same clamping screw, this is tightened with a 1/4 turn more.

13. Push bend protection springs over the clamping screw.
14. Attach bend protection springs to the hose connections for the particle filter, gas path connection and gas path plug.
15. Connect the particle filter, gas path connection and gas path plug to the hose connections.
16. Push the bend protection springs over the hose connections by pressing and simultaneously turning clockwise.
17. Fasten hose clamps to the gas sampling hose.

## 6.6. Cleaning the gas path in the probe handle

Check the gas path in the handle regularly for contamination.

1. Fix sampling tube and handle securely in place.



2. Remove the sampling tube (size SW13) from the handle (size SW19) using wrenches.



3. Undo upper hose clamp.
4. Remove bend protection springs from the thermocouple clamping screw.



5. Undo the thermocouple clamping screw using a wrench (size SW8).

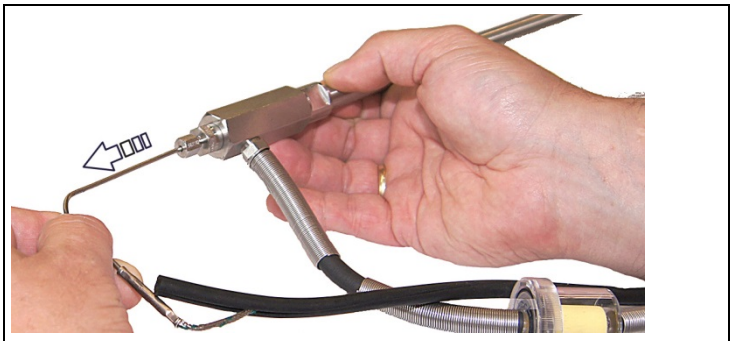

6. Carefully pull out thermocouple.



**ATTENTION**

Never pull on the connection cable when removing the thermocouple from the handle.

**Damage due to inappropriate handling!**

- > Hold thermocouple tightly in front of the ferrule and carefully pull it out of the handle.



7. Undo the clamping screw connection using a wrench (size SW12).

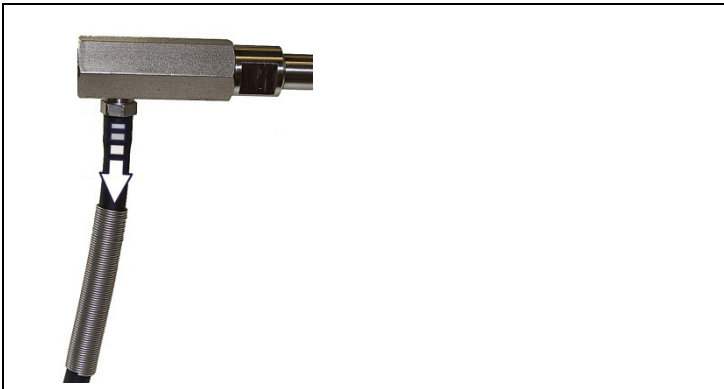

8. Remove bend protection spring and gas path hose at the gas path connection by turning clockwise.

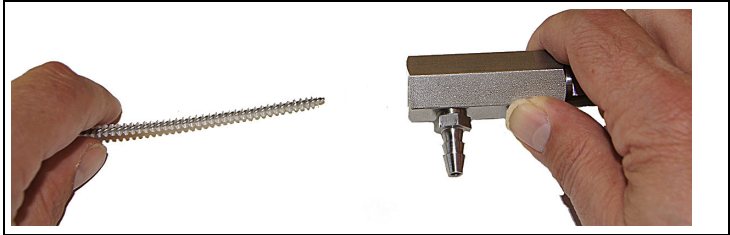

9. Insert the cleaning brush into the probe handle.
10. Push the cleaning brush through to the tip of the probe handle and pull out.
11. Repeat steps 9 and 10 several times depending on the degree of contamination.



12. Clean gas path connection.
13. Repeat step 11 several times depending on the degree of contamination.
14. Attach hose to the gas path connection and push bend protection springs over the gas path connection by pressing and turning clockwise simultaneously.
15. Tighten clamping screw connection on the probe handle using a wrench (size SW12), see Tightening torques for screw connections, page **30**.
16. Screw clamping screw on the clamping screw connection by hand as far as it will go.

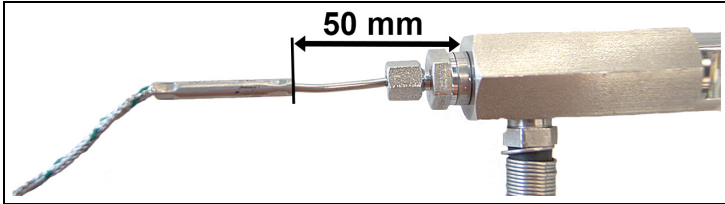

17. Carefully thread the thermocouple up to 50 mm through the clamping screw and the probe handle and into the probe shaft.
18. Tighten clamping screw using a wrench (size SW8), with 1 3/4 turns.

**i** When refitting the same clamping screw, this is tightened with a 1/4 turn more.

19. Push bend protection springs over the clamping screw.
20. Fasten upper hose clamp to the gas sampling hose.
21. Screw sampling tube onto the handle and tighten, see Tightening torques for screw connections, page 30.

## 6.7. Replacing the thermocouple

**i** Before replacing the thermocouple, disconnect the industrial flue gas probe from the Testo measuring instrument.

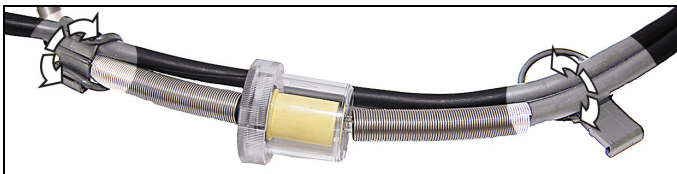

1. Undo all hose clamps on the gas sampling hose.



2. Remove bend protection springs from the thermocouple clamping screw.



3. Undo the thermocouple clamping screw using a wrench (size SW8).



4. Carefully pull out thermocouple.

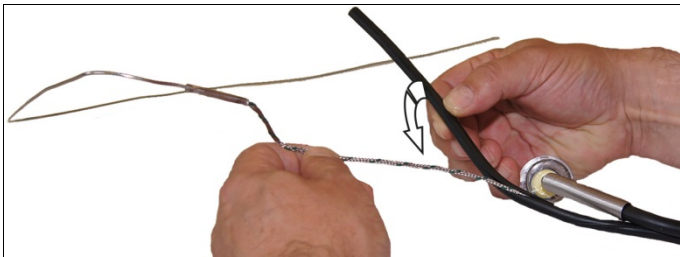

5. Remove the thermocouple cable, starting at the instrument plug, from the slotted tube.

**ATTENTION**

Never pull on the connection cable when removing the thermocouple from the handle.

**Damage due to inappropriate handling!**

- > Hold thermocouple tightly in front of the ferrule and carefully pull it out of the handle.

6. Remove bend protection spring from the thermocouple.
7. Attach bend protection spring to the new thermocouple.
8. Insert the new thermocouple cable, starting at the instrument plug, into the slotted tube.
9. Push the bend protection spring over the tube.

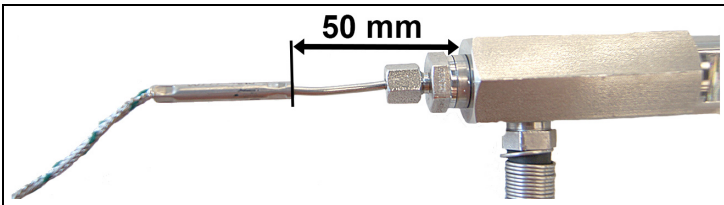

10. Carefully thread the new thermocouple up to 50 mm through the clamping screw and the probe handle into the probe shaft.
11. Screw the clamping screw by hand as far as it will go. Then tighten using a wrench (size SW8) with 1 3/4 turns.



When refitting the same clamping screw, this is tightened with a 1/4 turn more.

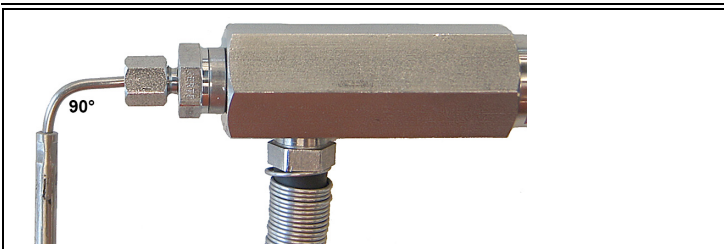

12. Carefully bend thermocouple 90° between ferrule and clamping screw connection. Do not kink the thermocouple.
13. Push bend protection springs over the clamping screw.
14. Fasten hose clamps to the gas sampling hose.

## 7 Tips and assistance

### 7.1. Recommendations and application instructions

<b>Application / problem</b>	<b>Recommendation / solution</b>
The screw connections are difficult to undo following usage at high temperatures (>600 °C).	Grease the threads of the screw connections with a standard ceramic paste before use.
In the event of heavy dust loads (e.g. measurement on a rotary kiln), the particle filter gets clogged very quickly.	To achieve a longer service life, replace the particle filter with a standard fuel filter. The measurement period can last 10 to 20 min as a result.
A filter cake forms on the probe shaft tip during measurement.	The filter cake can be knocked off either straight after measurement or once the cooling time has elapsed.

If we have not been able to answer your question, please contact your dealer or Testo Customer Service. For contact details, see the back of this document or visit the website [www.testo.com/service-contact](http://www.testo.com/service-contact).

### 7.2. Tightening torques for screw connections

<b>Screw connections</b>	<b>Tightening torque</b>
Handle - probe shaft	20 Nm
Probe shaft - probe shaft	20 Nm
Handle - gas path hose adapter	6 Nm
Handle - TC clamping screw connection	10 Nm
Probe shaft - preliminary filter	20 Nm
Preliminary filter: Filter nut - Filter seat	hand screwd

### 7.3. Accessories and spare parts

Description	Item no.
Probe preliminary filter for dusty/dirty flue gases	0600 7616
Extension/sampling tube, length 1000 mm, up to max. 1200 °C	0600 7617
Transport case for flue gas probes	0516 7600
Thermocouple, length 2200 mm, up to max. 1200 °C	0600 7615
Particle filter (housing incl. PE filter)	0440 0668
PE filter (10 pcs.)	0554 3371
Unheated probe handle	0440 0649
Spare thermocouple 1200 mm	0430 0088
Seal ring for thermocouple, stainless steel	0170 0474
Clamping screw connection for thermocouple	0400 0083
Unheated gas sampling hose	0554 3354
Spare filter element	0133 0043
Replacement ceramic sampling tube 1.800 °C	0440 0669
Adapter for ceramic sampling tube	0190 0186
O-ring for adapter	0135 0312

